

ROSE-MRK-BW

~70° batwing beam. Assembly with white holder.

SPECIFICATION:

Dimensions	21.6 x 21.6 mm
Height	13 mm
Fastening	tape, pin
ROHS compliant	yes ⓘ

MATERIALS:

Component	Type	Material	Colour	Finish
ROSE-MRK-BW	Single lens	PC	clear	
ROSE-MRK-LT-HLD	Holder	PC	white	
ROSE-TAPE	Tape	Acrylic foam	black	

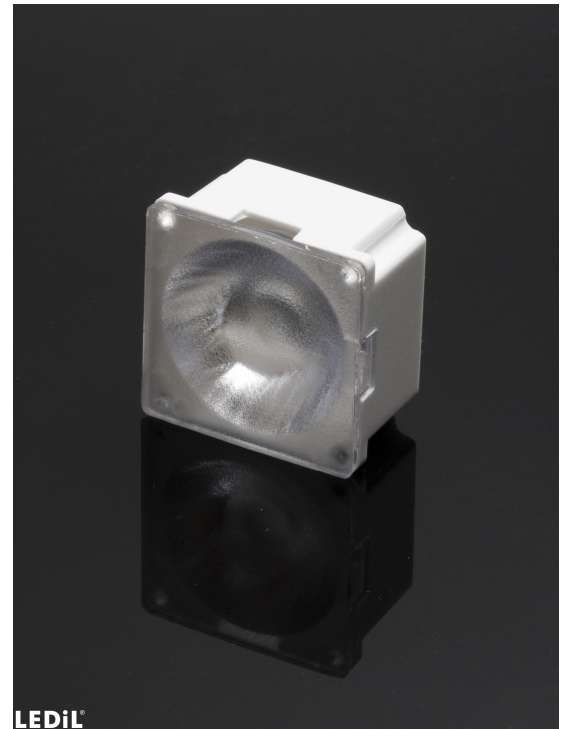

ORDERING INFORMATION:

Component	Type	Qty in box	MOQ	MPQ	Box weight (kg)
FA15480_ROSE-MRK-BW	Single lens	2304		144	10.0
» Box size: 470 x 235 x 270 mm					

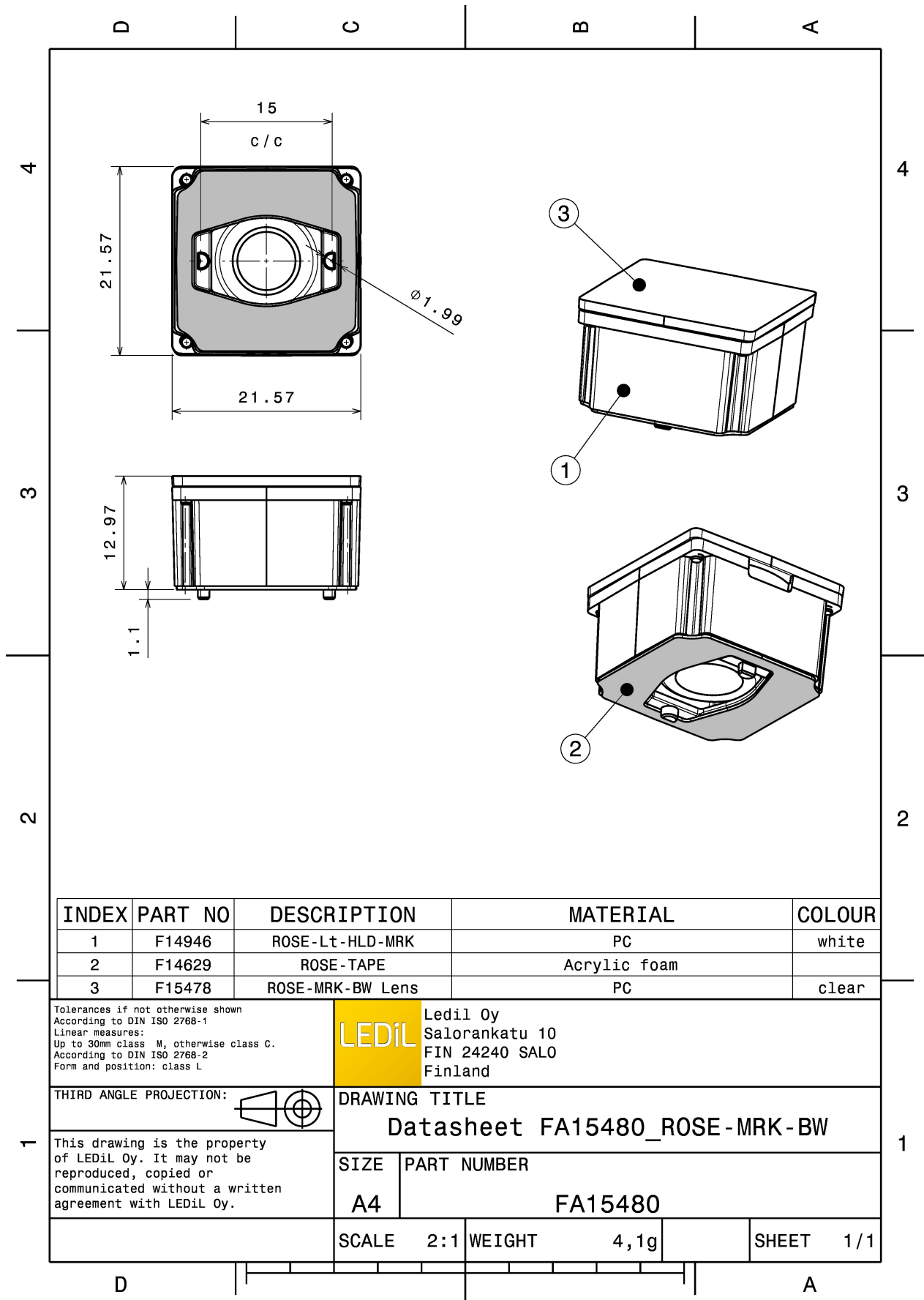

INDEX	PART NO	DESCRIPTION	MATERIAL	COLOUR
1	F14946	ROSE-Lt-HLD-MRK	PC	white
2	F14629	ROSE-TAPE	Acrylic foam	
3	F15478	ROSE-MRK-BW Lens	PC	clear

Tolerances if not otherwise shown
According to DIN ISO 2768-1
Linear measures:
Up to 30mm class M, otherwise class C.
According to DIN ISO 2768-2
Form and position: class L

LEDiL Ledil Oy
Salorankatu 10
FIN 24240 SALO
Finland

THIRD ANGLE PROJECTION:

DRAWING TITLE
Datasheet FA15480_ROSE-MRK-BW

This drawing is the property of LEDiL Oy. It may not be reproduced, copied or communicated without a written agreement with LEDiL Oy.

SIZE	PART NUMBER
A4	FA15480

SCALE	2:1	WEIGHT	4,1g	SHEET	1/1
-------	-----	--------	------	-------	-----

See also our general installation guide: www.ledil.com/installation_guide







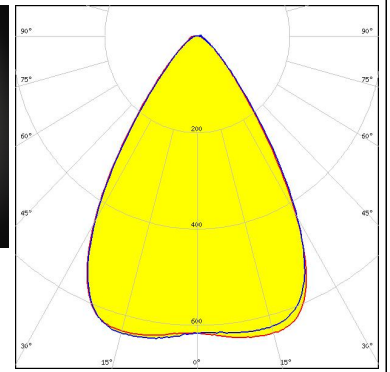
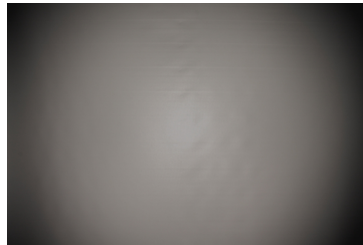

OPTICAL RESULTS (MEASURED):

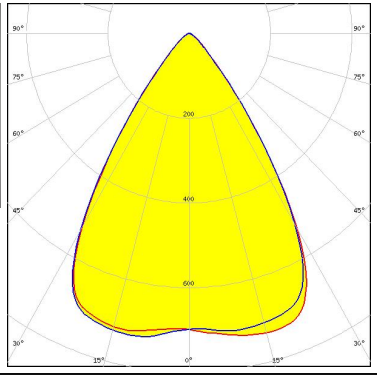

LED	LUXEON M/MX
FWHM / FWTM	68.0° / 101.0°
Efficiency	84 %
Peak intensity	0.7 cd/lm
LEDs/each optic	1
Light colour	White
Required components:	

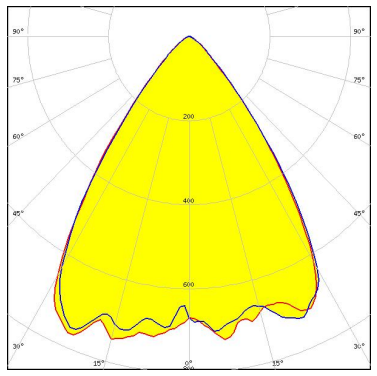

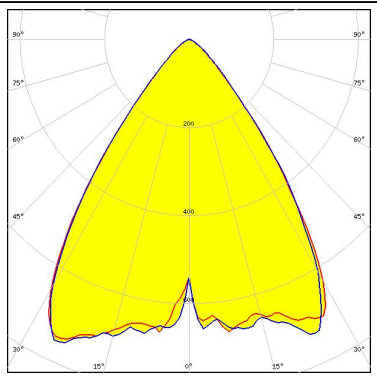
OPTICAL RESULTS (SIMULATED):

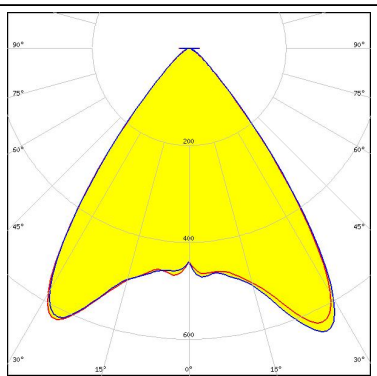
<p></p> <p>LED: Bridgelux SMD 5050 FWHM / FWTM: 62.0° / 86.0° Efficiency: 87 % Peak intensity: 0.8 cd/lm LEDs/each optic: 1 Light colour: White Required components:</p>		
<p></p> <p>LED: MK-R FWHM / FWTM: 63.0° / 90.0° Efficiency: 85 % Peak intensity: 0.7 cd/lm LEDs/each optic: 1 Light colour: White Required components:</p>		
<p></p> <p>LED: XHP50 FWHM / FWTM: 63.0° / 90.0° Efficiency: 84 % Peak intensity: 0.7 cd/lm LEDs/each optic: 1 Light colour: White Required components:</p>		
<p></p> <p>LED: XP-G3 FWHM / FWTM: 74.0° / 95.0° Efficiency: 84 % Peak intensity: 0.6 cd/lm LEDs/each optic: 1 Light colour: White Required components:</p>		

OPTICAL RESULTS (SIMULATED):



LED XP-L2
 FWHM / FWTM 74.0° / 96.0°
 Efficiency 84 %
 Peak intensity 0.7 cd/lm
 LEDs/each optic 1
 Light colour White
 Required components:

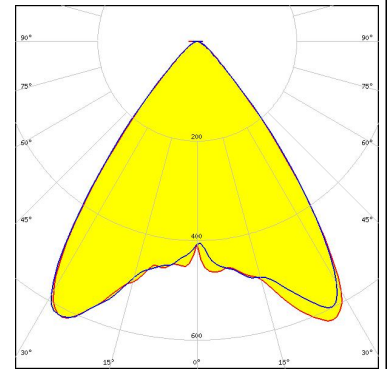

LED LUXEON 5050 Round LES
 FWHM / FWTM 68.0° / 88.0°
 Efficiency 87 %
 Peak intensity 0.8 cd/lm
 LEDs/each optic 1
 Light colour White
 Required components:

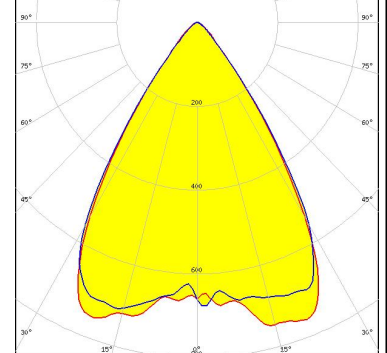

LED LUXEON 7070
 FWHM / FWTM 63.0° / 92.0°
 Efficiency 85 %
 Peak intensity 0.8 cd/lm
 LEDs/each optic 1
 Light colour White
 Required components:

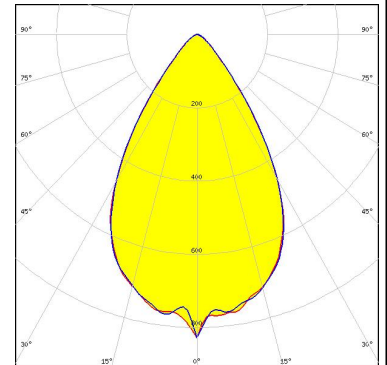

LED Z5M4
 FWHM / FWTM 68.0° / 84.0°
 Efficiency 87 %
 Peak intensity 0.8 cd/lm
 LEDs/each optic 1
 Light colour White
 Required components:

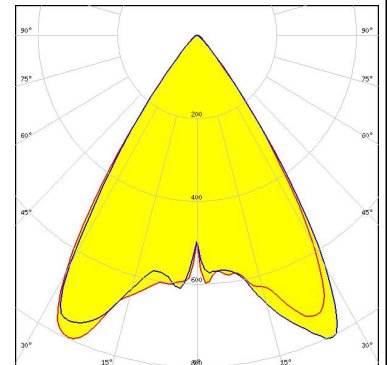

GENERAL INFORMATION:

NOTE: The typical beam angle will be changed by different color, chip size and chip position tolerance. The typical total beam angle is the full angle measured where the luminous intensity is half of the peak value.

MATERIALS:

As part of our continuous research and improvement processes, and to ensure the best possible quality and availability of our products, LEDiL reserves the right to change material grades without notice.

PRODUCT DATA USER AGREEMENT AND DISCLAIMER:

The measured data in the provided downloadable LEDiL Product Datasheets and Mechanical 2D-Drawings is rounded and provided as reference for planning. LEDiL Oy's optical specifications have been verified by conducting performance testing of the products in accordance with the company's quality system. The reported data are averaged results of multiple measurements with typical variation. LEDiL Oy reserves the right to without prior notification make changes and improvements to its products.

LEDiL Oy assumes neither warranty, nor guarantee nor any other liability of any kind for the contents and correctness of the provided data. The provided data has been generated with highest diligence but the provided data may in reality not represent the complete possible variation range of all intrinsic parameters. Therefore, in certain cases a deviation from the provided data could occur.

LEDiL Oy reserves the right to undertake technical changes of its products without further notification which could lead to changes in the provided data. LEDiL Oy assumes no liability of any kind for the possible deviation from any provided data or any other damage resulting from the usage of the provided data.

The user agrees to this disclaimer and user agreement with the download or usage of the provided files.

LEDiL Oy

Joensuunkatu 13
FI-24240 SALO
Finland

LEDiL Inc.

228 West Page Street
Suite D
Sycamore IL 60178
USA

Ledil Optics Technology (Shenzhen) Co., Ltd.

405 , Block B
Casic Motor Building
Shenzhen 518057
P.R.CHINA

Local sales and technical support

[www.ledil.com/
where_to_buy](http://www.ledil.com/where_to_buy)

Shipping locations

Salo, Finland
Hong Kong, China

Distribution Partners

[www.ledil.com/
where_to_buy](http://www.ledil.com/where_to_buy)