

## LISA3-S-PIN

~16° spot beam with location pin installation

### SPECIFICATION:

Dimensions	Ø 10.0 mm
Height	7 mm
Fastening	glue, pin
ROHS compliant	yes ⓘ

### MATERIALS:

Component	Type	Material	Colour	Finish
LISA3-S	Single lens	PMMA	clear	
LISA3-HLD-PIN	Holder	PC	black	

### ORDERING INFORMATION:

Component	Qty in box	MOQ	MPQ	Box weight (kg)
CP18419_LISA3-S-PIN » Box size: 273 x 183 x 135 mm	4000	48000	100	2.3



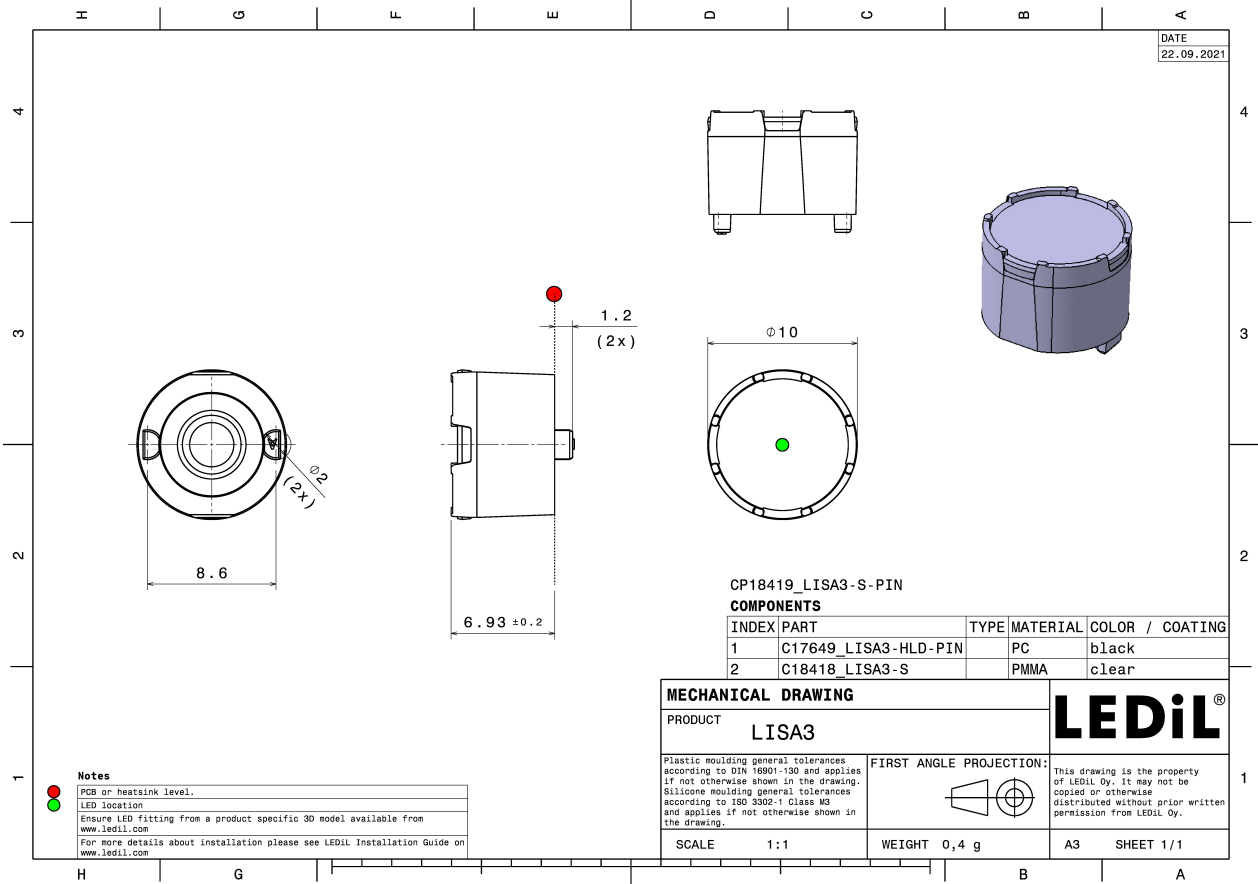

See also our general installation guide: [www.ledil.com/installation\\_guide](http://www.ledil.com/installation_guide)

#### OPTICAL RESULTS (MEASURED):



LED SST-10-B130  
FWHM / FWTM 20.0° / 36.0°  
Efficiency 82 %  
Peak intensity 5.4 cd/lm  
LEDs/each optic 1  
Light colour Blue  
Required components:

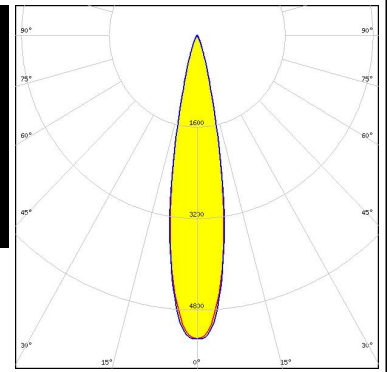
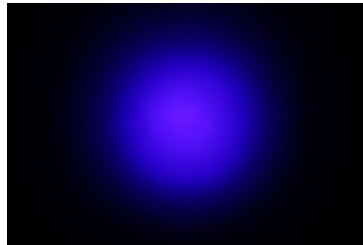

#### OPTICAL RESULTS (SIMULATED):

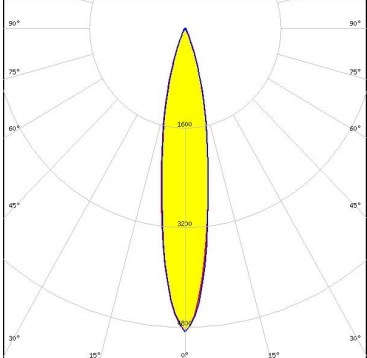
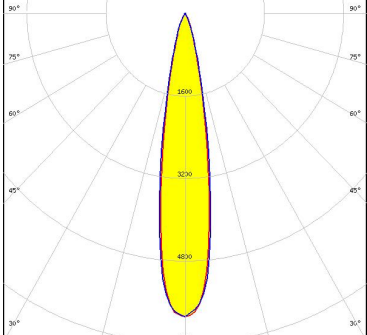
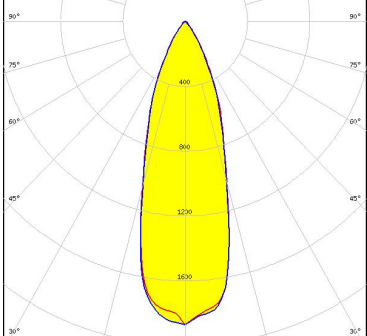
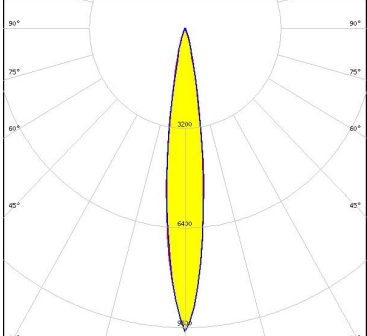
<p><b>bridgelux</b></p> <p>LED CSP 2323 (BXCP)            FWHM / FWTM 18.0° / 41.0°            Efficiency 81 %            Peak intensity 4.9 cd/lm            LEDs/each optic 1            Light colour White            Required components:</p>	
<p><b>LUMINUS</b></p> <p>LED SST-10-B130            FWHM / FWTM 19.0° / 37.0°            Efficiency 90 %            Peak intensity 5.9 cd/lm            LEDs/each optic 1            Light colour White            Required components:</p>	
<p><b>NICHIA</b></p> <p>LED NV4WB35AM            FWHM / FWTM 32.0° / 66.0°            Efficiency 85 %            Peak intensity 1.9 cd/lm            LEDs/each optic 1            Light colour White            Required components:</p>	
<p><b>OSRAM</b>  <small>Opto Semiconductors</small></p> <p>LED OSCONIQ P 3030            FWHM / FWTM 14.0° / 29.0°            Efficiency 89 %            Peak intensity 9.7 cd/lm            LEDs/each optic 1            Light colour White            Required components:</p>	

#### OPTICAL RESULTS (SIMULATED):

#### OSRAM

Opto Semiconductors

LED OSLON Square Flat  
 FWHM / FWTM 16.0° / 32.0°  
 Efficiency 89 %  
 Peak intensity 8.2 cd/lm  
 LEDs/each optic 1  
 Light colour White  
 Required components:

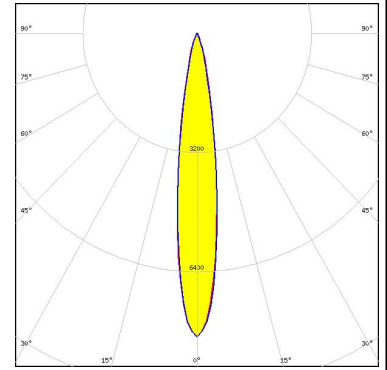

#### OSRAM

Opto Semiconductors

LED SFH 4716S  
 FWHM / FWTM 15.0° / 31.0°  
 Efficiency 87 %  
 LEDs/each optic 1  
 Light colour IR  
 Required components:

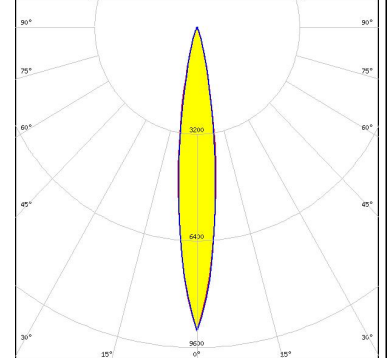
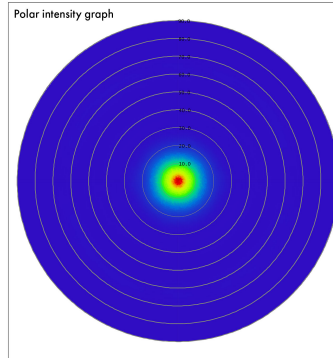

#### SAMSUNG

LED LH351B  
 FWHM / FWTM 24.0° / 46.0°  
 Efficiency 88 %  
 Peak intensity 3.7 cd/lm  
 LEDs/each optic 1  
 Light colour White  
 Required components:

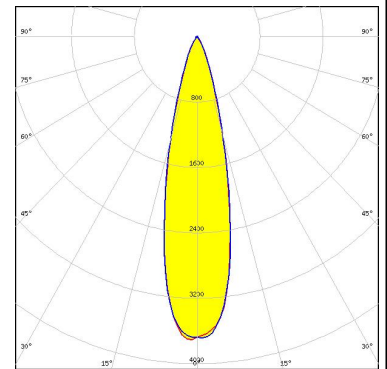

### GENERAL INFORMATION:

NOTE: The typical beam angle will be changed by different color, chip size and chip position tolerance. The typical total beam angle is the full angle measured where the luminous intensity is half of the peak value.

### MATERIALS:

As part of our continuous research and improvement processes, and to ensure the best possible quality and availability of our products, LEDiL reserves the right to change material grades without notice.

### PRODUCT DATA USER AGREEMENT AND DISCLAIMER:

The measured data in the provided downloadable LEDiL Product Datasheets and Mechanical 2D-Drawings is rounded and provided as reference for planning. LEDiL Oy's optical specifications have been verified by conducting performance testing of the products in accordance with the company's quality system. The reported data are averaged results of multiple measurements with typical variation. LEDiL Oy reserves the right to without prior notification make changes and improvements to its products.

LEDiL Oy assumes neither warranty, nor guarantee nor any other liability of any kind for the contents and correctness of the provided data. The provided data has been generated with highest diligence but the provided data may in reality not represent the complete possible variation range of all intrinsic parameters. Therefore, in certain cases a deviation from the provided data could occur.

LEDiL Oy reserves the right to undertake technical changes of its products without further notification which could lead to changes in the provided data. LEDiL Oy assumes no liability of any kind for the possible deviation from any provided data or any other damage resulting from the usage of the provided data.

The user agrees to this disclaimer and user agreement with the download or usage of the provided files.

#### LEDiL Oy

Joensuunkatu 13  
FI-24240 SALO  
Finland

#### LEDiL Inc.

228 West Page Street  
Suite D  
Sycamore IL 60178  
USA

#### Ledil Optics Technology (Shenzhen) Co., Ltd.

# 405 , Block B  
Casic Motor Building  
Shenzhen 518057  
P.R.CHINA

#### Local sales and technical support

[www.ledil.com/  
where\\_to\\_buy](http://www.ledil.com/where_to_buy)

#### Shipping locations

Salo, Finland  
Hong Kong, China

#### Distribution Partners

[www.ledil.com/  
where\\_to\\_buy](http://www.ledil.com/where_to_buy)