

KIKI-A

~165° wide beam. Assembly with installation tape.

SPECIFICATION:

Dimensions	21.6 x 14.0 mm
Height	5.9 mm
Fastening	tape, pin
ROHS compliant	yes ⓘ

MATERIALS:

Component	Type	Material	Colour	Finish
KIKI-A	Single lens	PMMA	clear	
SIRI-TAPE-3	Tape			

ORDERING INFORMATION:

Component		Qty in box	MOQ	MPQ	Box weight (kg)
CA13747_KIKI-A	Single lens	4032	378	126	3.5
» Box size: 451 x 254 x 152 mm					

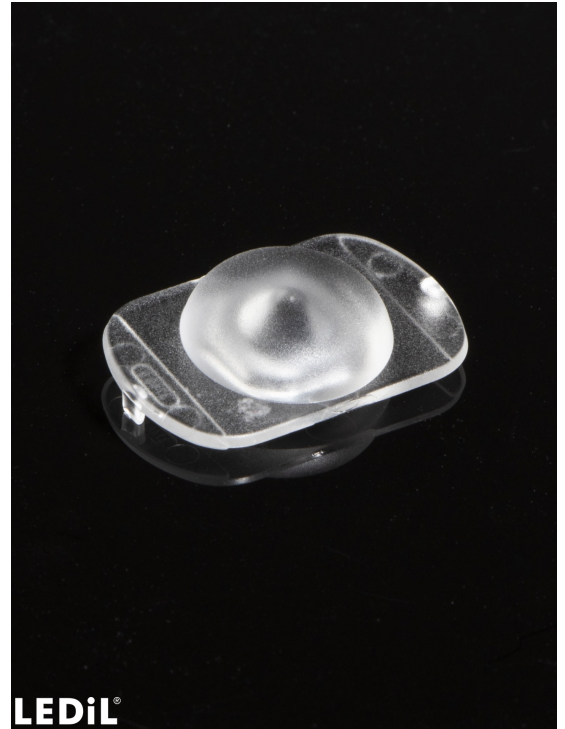

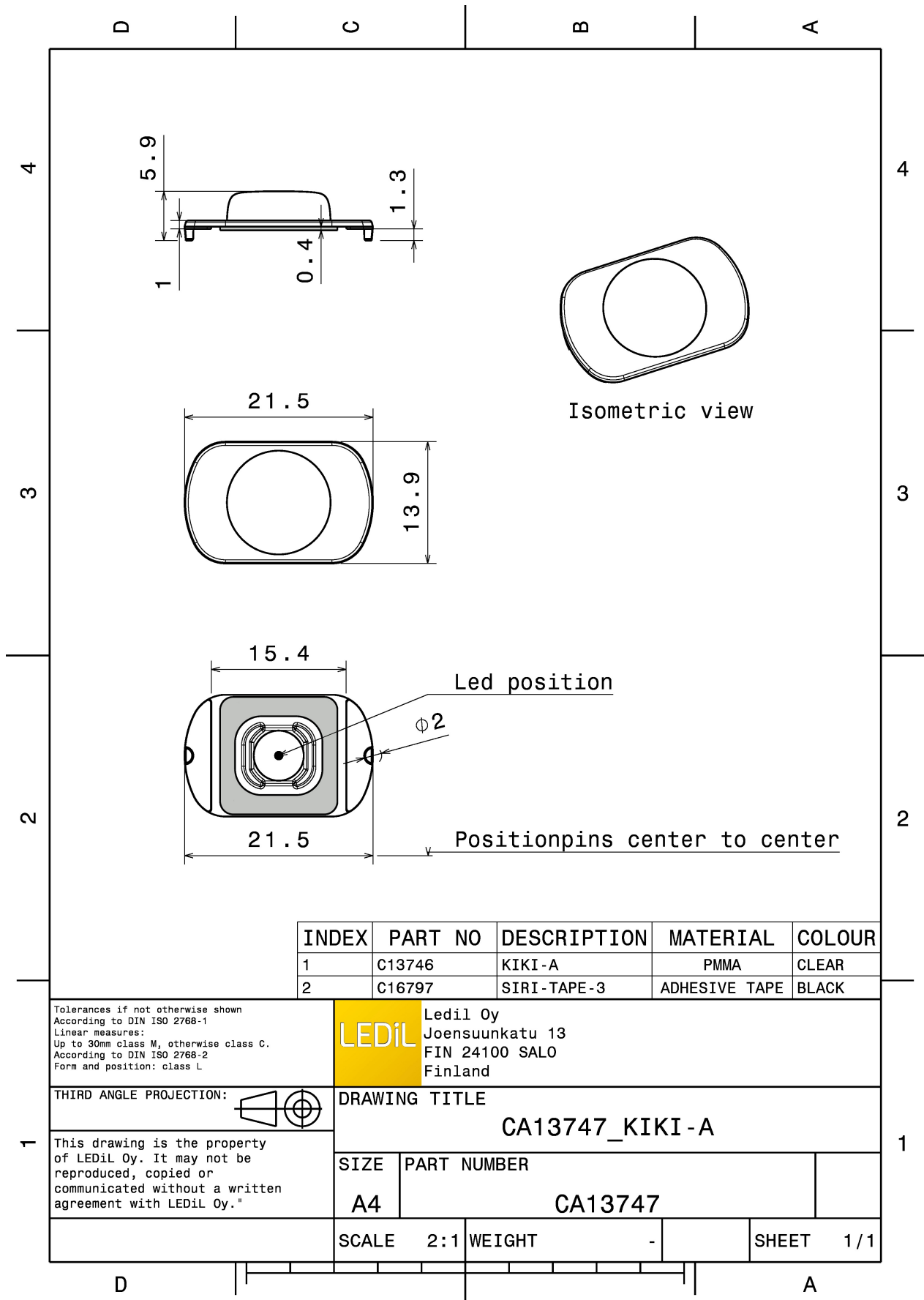

See also our general installation guide: www.ledil.com/installation_guide

OPTICAL RESULTS (MEASURED):

LUMILEDS

LED LUXEON T
FWHM / FWTM 162.0° / 183.0°
Efficiency 91 %
Peak intensity 0.3 cd/lm
LEDs/each optic 1
Light colour White
Required components:

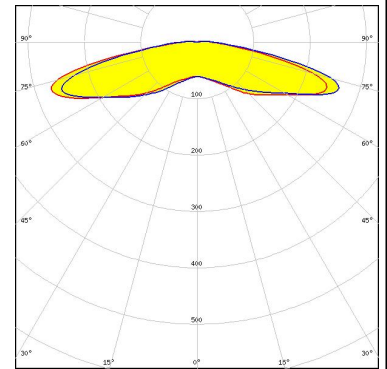

LUMILEDS

LED LUXEON TX
FWHM / FWTM 162.0° / 185.0°
Efficiency 90 %
Peak intensity 0.3 cd/lm
LEDs/each optic 1
Light colour White
Required components:

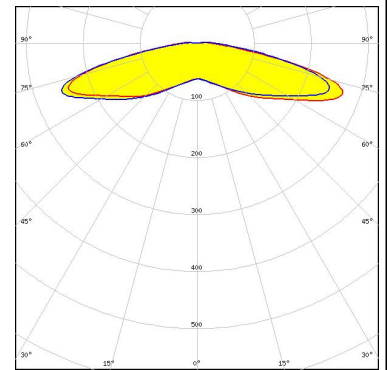

NICHIA

LED NVSxx19B/NVSxx19C
FWHM / FWTM 161.0° / 181.0°
Efficiency 88 %
Peak intensity 0.3 cd/lm
LEDs/each optic 1
Light colour White
Required components:

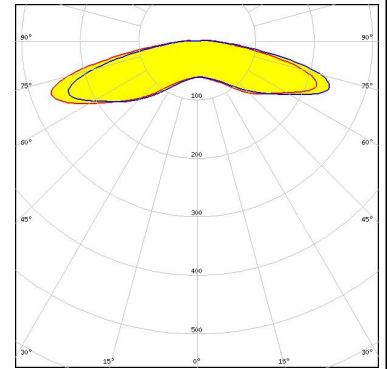

OSRAM Opto Semiconductors

LED OSLOM Square PC
FWHM / FWTM 161.0° / 180.0°
Efficiency 88 %
Peak intensity 0.3 cd/lm
LEDs/each optic 1
Light colour White
Required components:

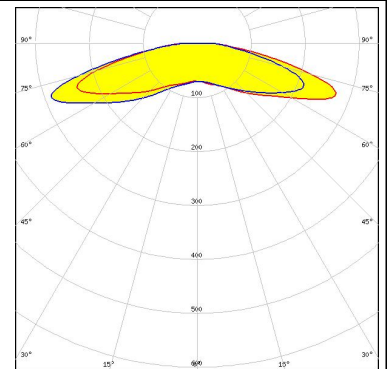

OPTICAL RESULTS (SIMULATED):



LED J Series 2835
 FWHM / FWTM 158.0° / 171.0°
 Efficiency 95 %
 Peak intensity 0.3 cd/lm
 LEDs/each optic 1
 Light colour White
 Required components:

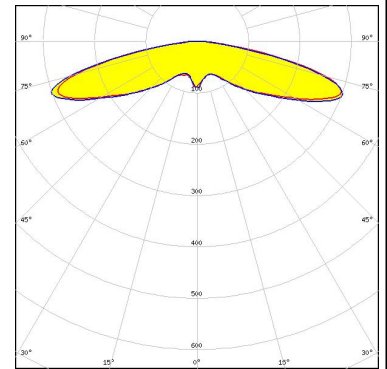

LED J Series 3030
 FWHM / FWTM 155.0° / 167.0°
 Efficiency 94 %
 Peak intensity 0.4 cd/lm
 LEDs/each optic 1
 Light colour White
 Required components:

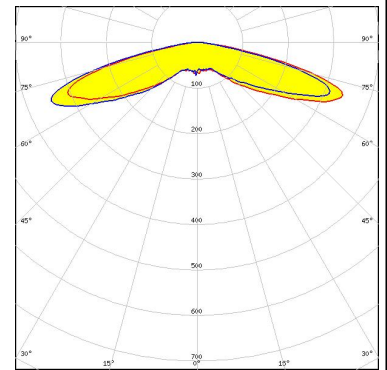

LED NFSx757G
 FWHM / FWTM 158.0° / 170.0°
 Efficiency 95 %
 Peak intensity 0.3 cd/lm
 LEDs/each optic 1
 Light colour White
 Required components:

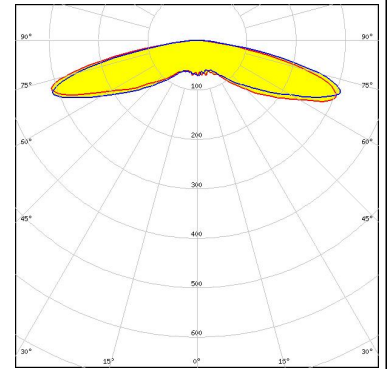

LED OSLOM Square CSSRM2/CSSRM3
 FWHM / FWTM 166.0° / 180.0°
 Efficiency 93 %
 Peak intensity 0.3 cd/lm
 LEDs/each optic 1
 Light colour White
 Required components:

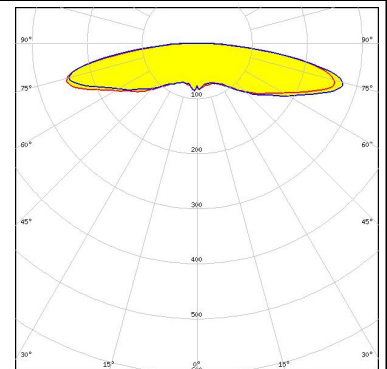

OPTICAL RESULTS (SIMULATED):

SAMSUNG

LED LM28xB Series
FWHM / FWTM 157.0° / 172.0°
Efficiency 96 %
Peak intensity 0.3 cd/lm
LEDs/each optic 1
Light colour White
Required components:

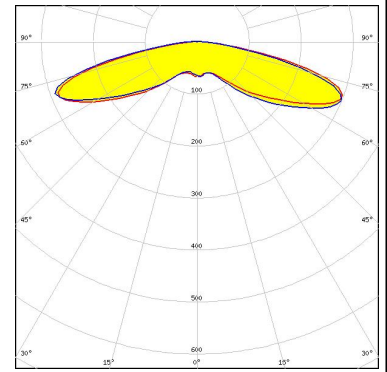

SAMSUNG

LED LM301B
FWHM / FWTM 158.0° / 170.0°
Efficiency 94 %
Peak intensity 0.3 cd/lm
LEDs/each optic 1
Light colour White
Required components:

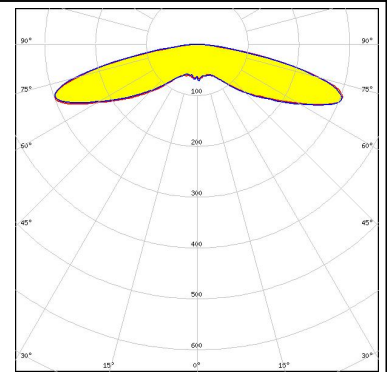

SEOUL SEMICONDUCTOR

LED Z8Y11
FWHM / FWTM 152.0° / 165.0°
Efficiency 93 %
Peak intensity 0.4 cd/lm
LEDs/each optic 1
Light colour White
Required components:

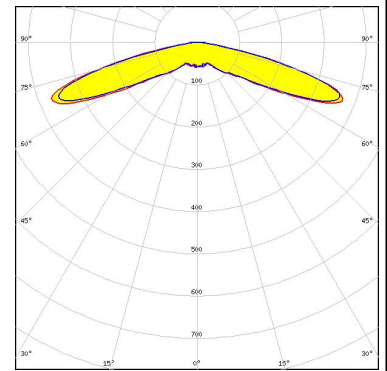

GENERAL INFORMATION:

NOTE: The typical beam angle will be changed by different color, chip size and chip position tolerance. The typical total beam angle is the full angle measured where the luminous intensity is half of the peak value.

MATERIALS:

As part of our continuous research and improvement processes, and to ensure the best possible quality and availability of our products, LEDiL reserves the right to change material grades without notice.

PRODUCT DATA USER AGREEMENT AND DISCLAIMER:

The measured data in the provided downloadable LEDiL Product Datasheets and Mechanical 2D-Drawings is rounded and provided as reference for planning. LEDiL Oy's optical specifications have been verified by conducting performance testing of the products in accordance with the company's quality system. The reported data are averaged results of multiple measurements with typical variation. LEDiL Oy reserves the right to without prior notification make changes and improvements to its products.

LEDiL Oy assumes neither warranty, nor guarantee nor any other liability of any kind for the contents and correctness of the provided data. The provided data has been generated with highest diligence but the provided data may in reality not represent the complete possible variation range of all intrinsic parameters. Therefore, in certain cases a deviation from the provided data could occur.

LEDiL Oy reserves the right to undertake technical changes of its products without further notification which could lead to changes in the provided data. LEDiL Oy assumes no liability of any kind for the possible deviation from any provided data or any other damage resulting from the usage of the provided data.

The user agrees to this disclaimer and user agreement with the download or usage of the provided files.

LEDiL Oy

Joensuunkatu 13
FI-24240 SALO
Finland

LEDiL Inc.

228 West Page Street
Suite D
Sycamore IL 60178
USA

Ledil Optics Technology (Shenzhen) Co., Ltd.

405 , Block B
Casic Motor Building
Shenzhen 518057
P.R.CHINA

Local sales and technical support

[www.ledil.com/
where_to_buy](http://www.ledil.com/where_to_buy)

Shipping locations

Salo, Finland
Hong Kong, China

Distribution Partners

[www.ledil.com/
where_to_buy](http://www.ledil.com/where_to_buy)