

EMILY-O-WAS

~45° x 10° oval beam for wall washing. 14.95 mm high lens.

SPECIFICATION:

Dimensions	Ø 26.0 mm
Height	15 mm
Fastening	tape, pin
ROHS compliant	yes ⓘ

MATERIALS:

Component	Type	Material	Colour	Finish
EMILY-O-WAS	Single lens	PMMA	clear	
SPUTNIK-TAPE	Tape	Acrylic foam	black	

ORDERING INFORMATION:

Component		Qty in box	MOQ	MPQ	Box weight (kg)
CA12000_EMILY-O-WAS	Single lens	1690	260	130	11.6
» Box size: 480 x 280 x 300 mm					



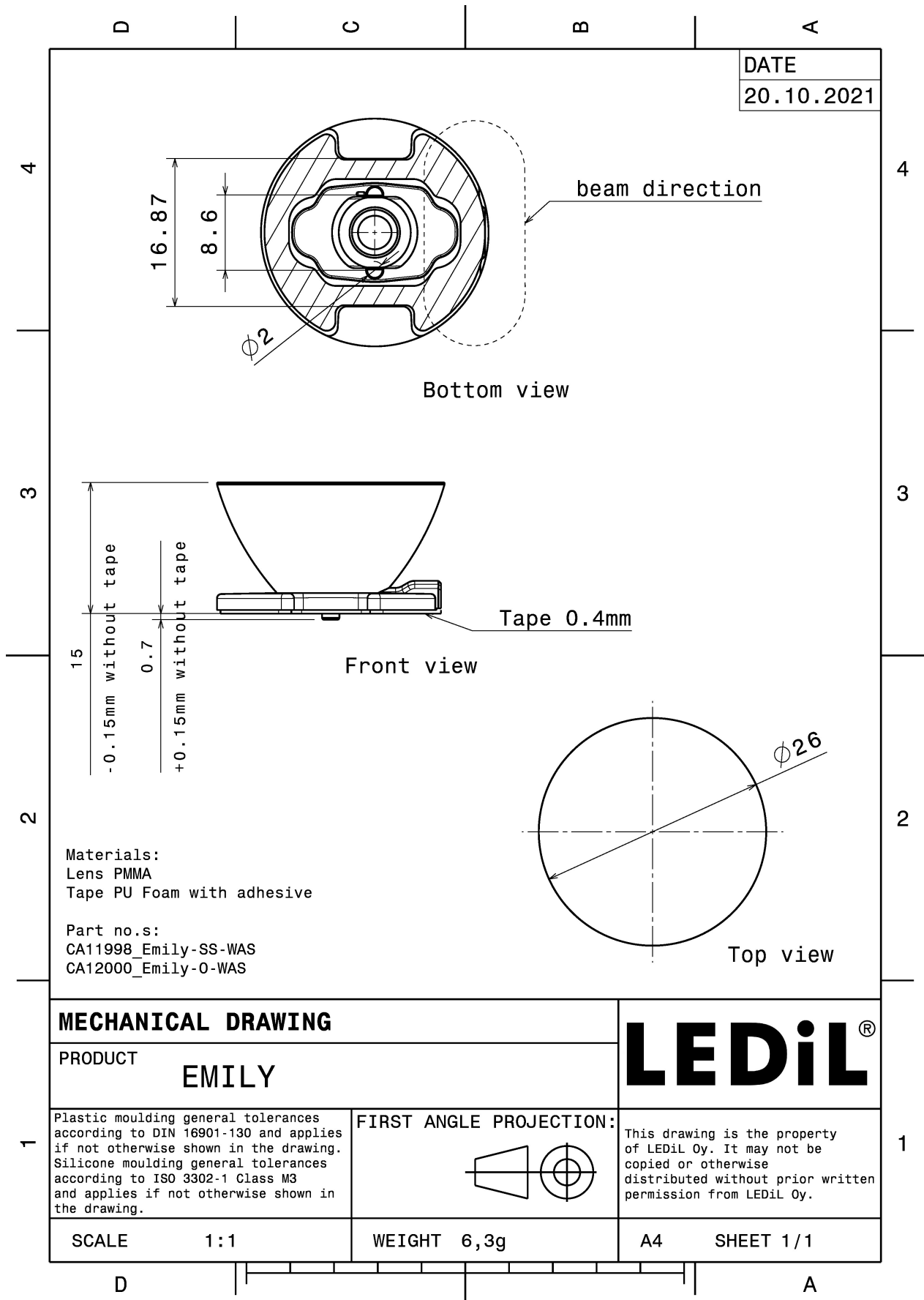

See also our general installation guide: www.ledil.com/installation_guide

OPTICAL RESULTS (MEASURED):



LED XHP35 HD
 FWHM / FWTM Asymmetric
 Efficiency 90 %
 Peak intensity 3.2 cd/m
 LEDs/each optic 1
 Light colour White
 Required components:

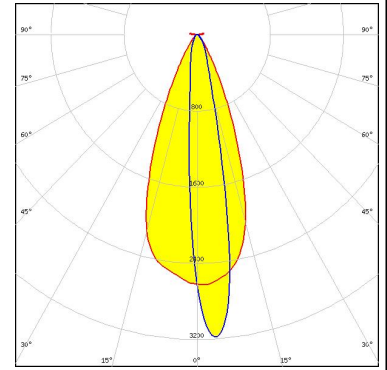

LED XP-E
 FWHM / FWTM Asymmetric
 Efficiency 87 %
 LEDs/each optic 1
 Light colour White
 Required components:

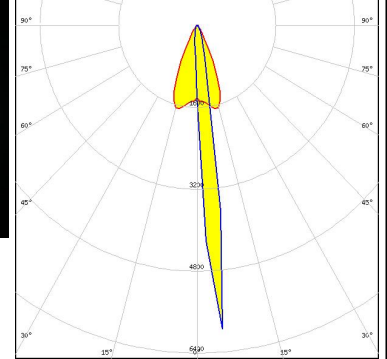

LED XP-G
 FWHM / FWTM Asymmetric
 Efficiency 87 %
 Peak intensity 4.2 cd/m
 LEDs/each optic 1
 Light colour White
 Required components:

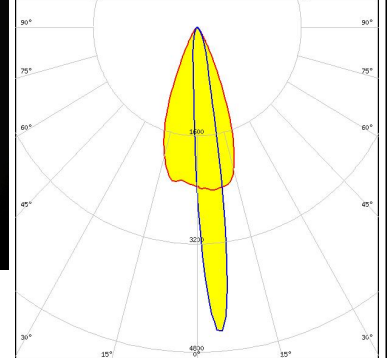

LED XP-L HI
 FWHM / FWTM Asymmetric
 Efficiency 88 %
 Peak intensity 5.2 cd/m
 LEDs/each optic 1
 Light colour White
 Required components:

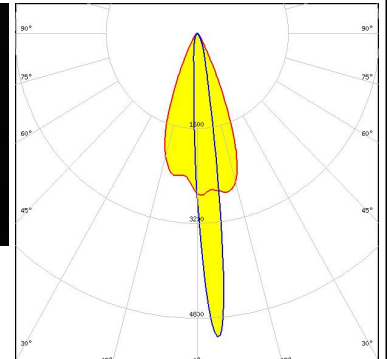
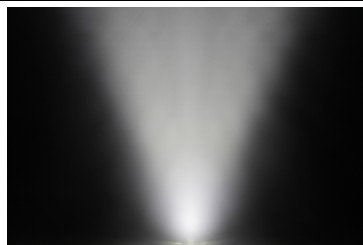

OPTICAL RESULTS (MEASURED):

LUMILEDS

LED LUXEON A
 FWHM / FWTM 43.0 + 10.0° / 60.0 + 28.0°
 Efficiency 87 %
 Peak intensity 3.8 cd/lm
 LEDs/each optic 1
 Light colour White
 Required components:

LUMILEDS

LED LUXEON Rebel
 FWHM / FWTM 8.0 + 47.0° / 68.0°
 Efficiency 87 %
 Peak intensity 1.5 cd/lm
 LEDs/each optic 1
 Light colour White
 Required components:

LUMILEDS

LED LUXEON Rebel ES
 FWHM / FWTM 43.0 + 10.0° / 60.0 + 28.0°
 Efficiency 87 %
 Peak intensity 3.7 cd/lm
 LEDs/each optic 1
 Light colour White
 Required components:

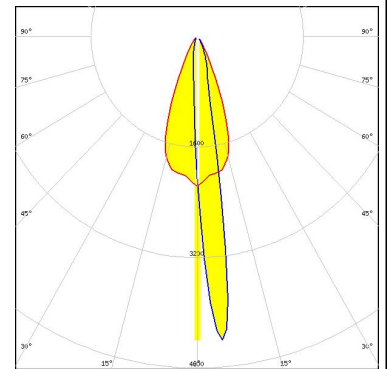

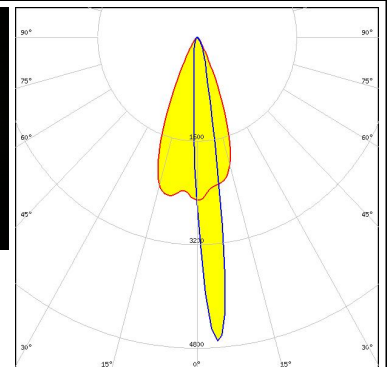

LUMILEDS

LED LUXEON T
 FWHM / FWTM 43.0 + 9.0° / 63.0 + 24.0°
 Efficiency 84 %
 Peak intensity 4.7 cd/lm
 LEDs/each optic 1
 Light colour White
 Required components:

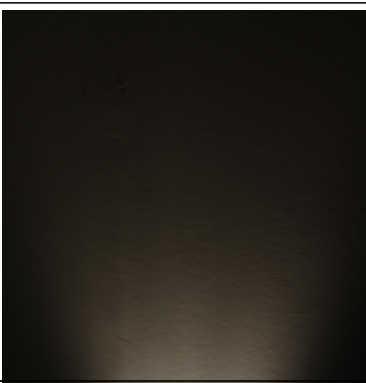
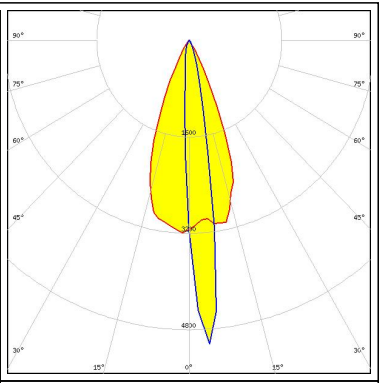
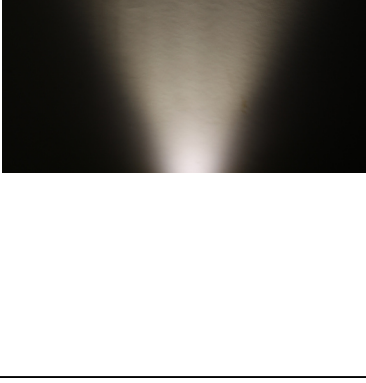
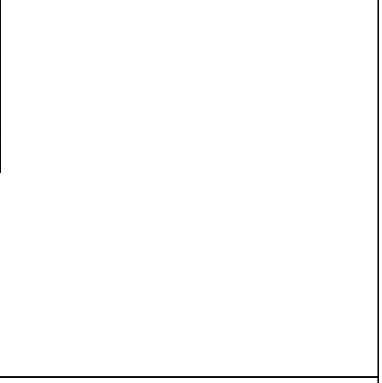
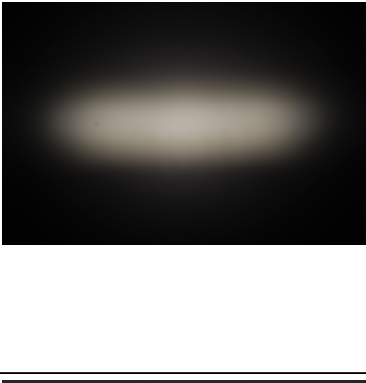
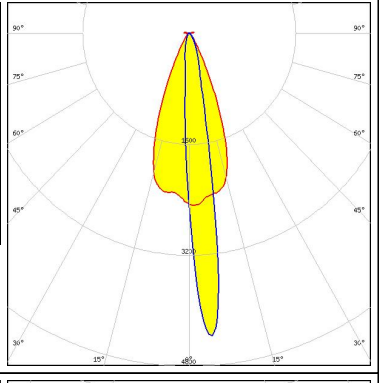

OPTICAL RESULTS (MEASURED):

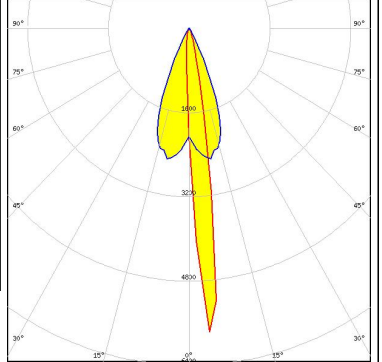
<p>LUMILEDS</p> <p>LED LUXEON TX</p> <p>FWHM / FWTM Asymmetric</p> <p>Efficiency 86 %</p> <p>Peak intensity 5.1 cd/lm</p> <p>LEDs/each optic 1</p> <p>Light colour White</p> <p>Required components:</p>		
<p>NICHIA</p> <p>LED NVSxx19A</p> <p>FWHM / FWTM 43.0 + 12.0° / 61.0 + 34.0°</p> <p>Efficiency 85 %</p> <p>Peak intensity 3.1 cd/lm</p> <p>LEDs/each optic 1</p> <p>Light colour White</p> <p>Required components:</p>		
<p>NICHIA</p> <p>LED NVSxx19B/NVSxx19C</p> <p>FWHM / FWTM Asymmetric</p> <p>Efficiency 91 %</p> <p>Peak intensity 4.5 cd/lm</p> <p>LEDs/each optic 1</p> <p>Light colour White</p> <p>Required components:</p>		
<p>OSRAM Opto Semiconductors</p> <p>LED OSLON SSL 150</p> <p>FWHM / FWTM 42.0 + 8.0° / 55.0 + 21.0°</p> <p>Efficiency 87 %</p> <p>Peak intensity 5 cd/lm</p> <p>LEDs/each optic 1</p> <p>Light colour White</p> <p>Required components:</p>		

OPTICAL RESULTS (MEASURED):

OSRAM Opto Semiconductors

LED OSLON SSL 80
FWHM / FWTM 42.0 + 9.0° / 59.0 + 28.0°
Efficiency 87 %
Peak intensity 3.9 cd/lm
LEDs/each optic 1
Light colour White
Required components:







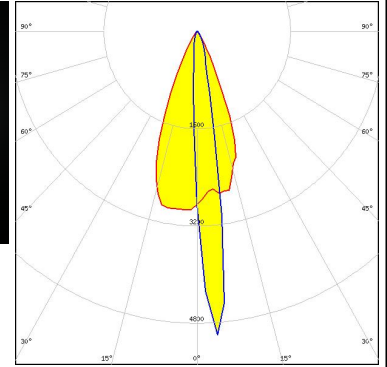

SEOUL SEMICONDUCTOR

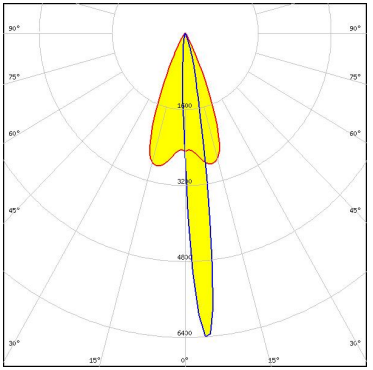
LED Z5M1/Z5M2
FWHM / FWTM Asymmetric
Efficiency 85 %
Peak intensity 5 cd/lm
LEDs/each optic 1
Light colour White
Required components:

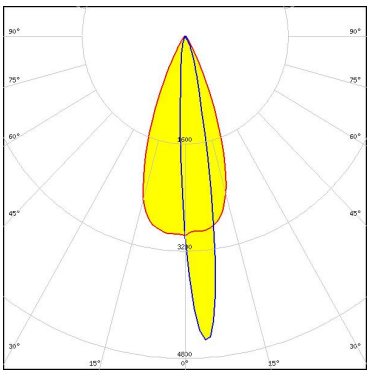

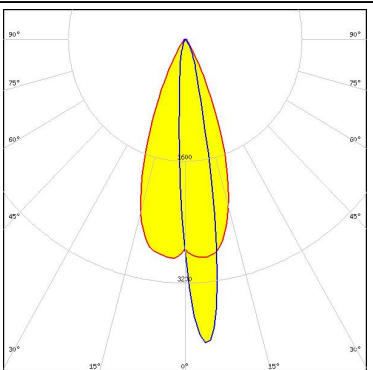
OPTICAL RESULTS (SIMULATED):

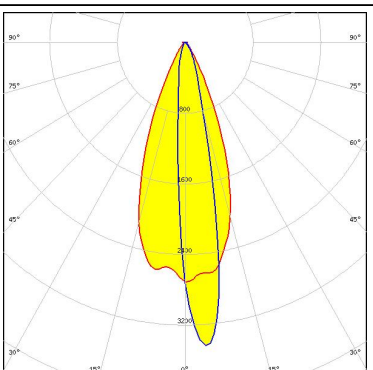
	<p>LED XP-E2 FWHM / FWTM Asymmetric Efficiency 95 % Peak intensity 6.8 cd/lm LEDs/each optic 1 Light colour White Required components:</p>	
	<p>LED XP-G3 FWHM / FWTM Asymmetric Efficiency 91 % Peak intensity 4.6 cd/lm LEDs/each optic 1 Light colour White Required components:</p>	
	<p>LED XP-L HD FWHM / FWTM Asymmetric Efficiency 92 % Peak intensity 4.1 cd/lm LEDs/each optic 1 Light colour White Required components:</p>	
	<p>LED XP-L2 FWHM / FWTM Asymmetric Efficiency 90 % Peak intensity 3.5 cd/lm LEDs/each optic 1 Light colour White Required components:</p>	

OPTICAL RESULTS (SIMULATED):



LED XT-E
 FWHM / FWTM Asymmetric
 Efficiency 92 %
 Peak intensity 5.4 cd/lm
 LEDs/each optic 1
 Light colour White
 Required components:

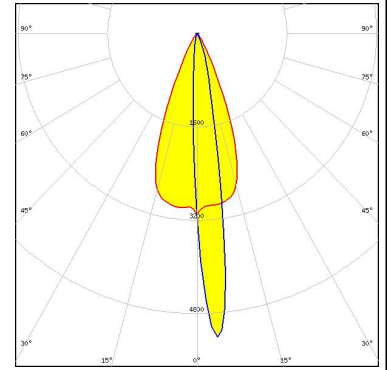

LED LUXEON H50-2
 FWHM / FWTM Asymmetric
 Efficiency 90 %
 Peak intensity 5.3 cd/lm
 LEDs/each optic 1
 Light colour White
 Required components:

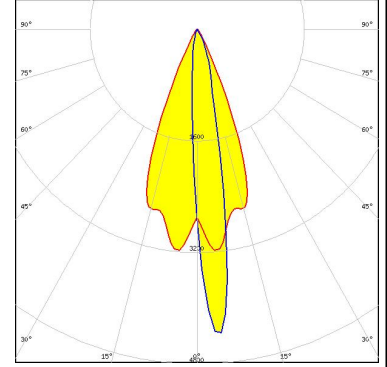

LED LUXEON Z ES
 FWHM / FWTM Asymmetric
 Efficiency 95 %
 Peak intensity 6.8 cd/lm
 LEDs/each optic 1
 Light colour White
 Required components:

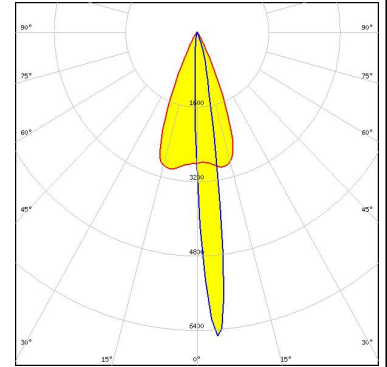

LED NV4WB35AM
 FWHM / FWTM Asymmetric
 Efficiency 92 %
 Peak intensity 3.9 cd/lm
 LEDs/each optic 1
 Light colour White
 Required components:

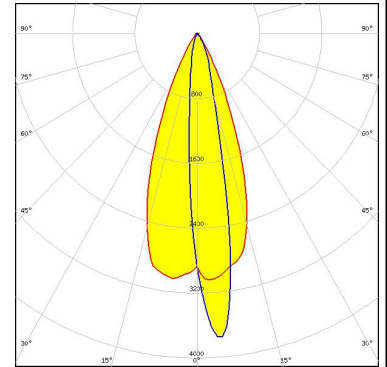

OPTICAL RESULTS (SIMULATED):

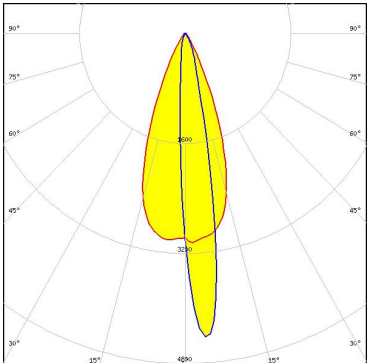
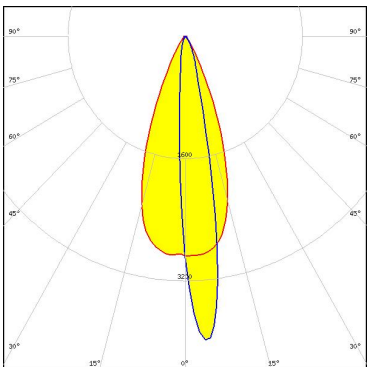
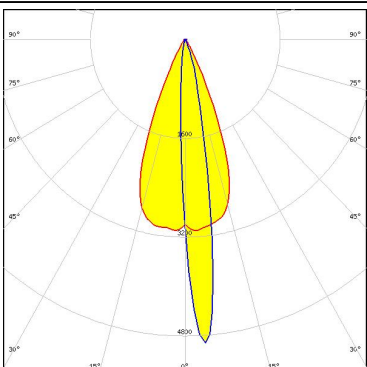
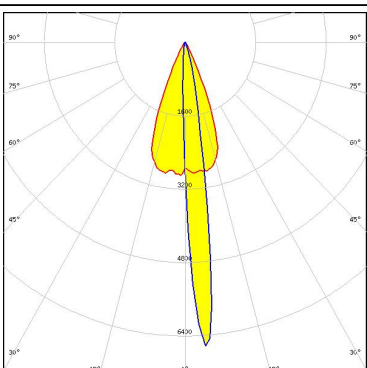
<p>NICHIA</p> <p>LED: NVSW319B FWHM / FWTM: Asymmetric Efficiency: 92 % Peak intensity: 4.5 cd/lm LEDs/each optic: 1 Light colour: White Required components:</p>	
<p>NICHIA</p> <p>LED: NVSW519A FWHM / FWTM: Asymmetric Efficiency: 90 % Peak intensity: 4 cd/lm LEDs/each optic: 1 Light colour: White Required components:</p>	
<p>NICHIA</p> <p>LED: NVSxE21A FWHM / FWTM: Asymmetric Efficiency: 90 % Peak intensity: 5 cd/lm LEDs/each optic: 1 Light colour: White Required components:</p>	
<p>OSRAM <small>Opto Semiconductors</small></p> <p>LED: OSCONIQ P 3030 FWHM / FWTM: Asymmetric Efficiency: 94 % Peak intensity: 6.7 cd/lm LEDs/each optic: 1 Light colour: White Required components:</p>	

OPTICAL RESULTS (SIMULATED):

OSRAM

Opto Semiconductors

LED OSLOM Square CSSRM2/CSSRM3
 FWHM / FWTM 44.0 + 9.0° / 62.0 + 25.0°
 Efficiency 93 %
 Peak intensity 5.6 cd/lm
 LEDs/each optic 1
 Light colour White
 Required components:

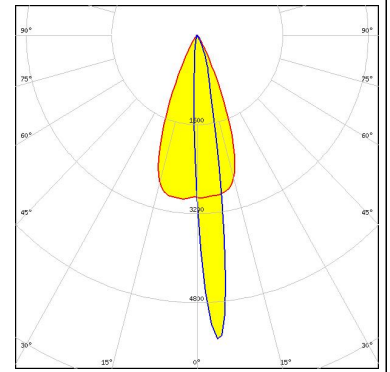

OSRAM

Opto Semiconductors

LED OSLOM Square EC
 FWHM / FWTM Asymmetric
 Efficiency 92 %
 Peak intensity 0.6 cd/lm
 LEDs/each optic 1
 Light colour White
 Required components:

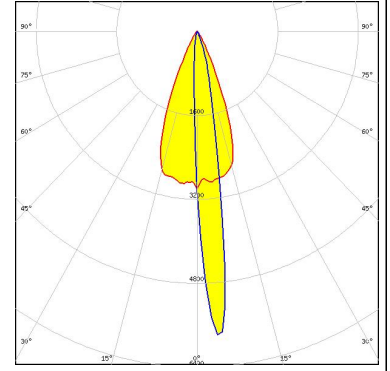

SAMSUNG

LED LH351C
 FWHM / FWTM Asymmetric
 Efficiency 93 %
 Peak intensity 4.4 cd/lm
 LEDs/each optic 1
 Light colour White
 Required components:

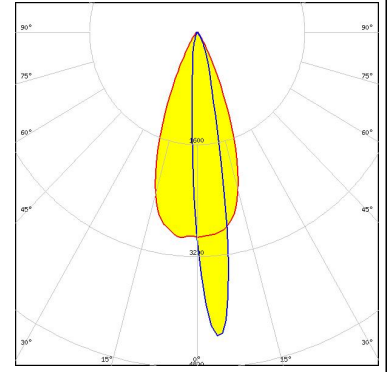

GENERAL INFORMATION:

NOTE: The typical beam angle will be changed by different color, chip size and chip position tolerance. The typical total beam angle is the full angle measured where the luminous intensity is half of the peak value.

MATERIALS:

As part of our continuous research and improvement processes, and to ensure the best possible quality and availability of our products, LEDiL reserves the right to change material grades without notice.

PRODUCT DATA USER AGREEMENT AND DISCLAIMER:

The measured data in the provided downloadable LEDiL Product Datasheets and Mechanical 2D-Drawings is rounded and provided as reference for planning. LEDiL Oy's optical specifications have been verified by conducting performance testing of the products in accordance with the company's quality system. The reported data are averaged results of multiple measurements with typical variation. LEDiL Oy reserves the right to without prior notification make changes and improvements to its products.

LEDiL Oy assumes neither warranty, nor guarantee nor any other liability of any kind for the contents and correctness of the provided data. The provided data has been generated with highest diligence but the provided data may in reality not represent the complete possible variation range of all intrinsic parameters. Therefore, in certain cases a deviation from the provided data could occur.

LEDiL Oy reserves the right to undertake technical changes of its products without further notification which could lead to changes in the provided data. LEDiL Oy assumes no liability of any kind for the possible deviation from any provided data or any other damage resulting from the usage of the provided data.

The user agrees to this disclaimer and user agreement with the download or usage of the provided files.

LEDiL Oy

Joensuunkatu 13
FI-24240 SALO
Finland

LEDiL Inc.

228 West Page Street
Suite D
Sycamore IL 60178
USA

Ledil Optics Technology (Shenzhen) Co., Ltd.

405 , Block B
Casic Motor Building
Shenzhen 518057
P.R.CHINA

Local sales and technical support

[www.ledil.com/
where_to_buy](http://www.ledil.com/where_to_buy)

Shipping locations

Salo, Finland
Hong Kong, China

Distribution Partners

[www.ledil.com/
where_to_buy](http://www.ledil.com/where_to_buy)