

### CARMEN-W-B

~55° wide beam. Assembly with holder B compatible with Ø40 mm BJB and B+W connectors.

#### SPECIFICATION:

Dimensions	Ø 69.5 mm
Height	36.3 mm
Fastening	socket
ROHS compliant	yes ⓘ



#### MATERIALS:

Component	Type	Material	Colour	Finish
CARMEN-W	Single lens	PMMA	clear	
CARMEN-HLD-B	Holder	PC	black	



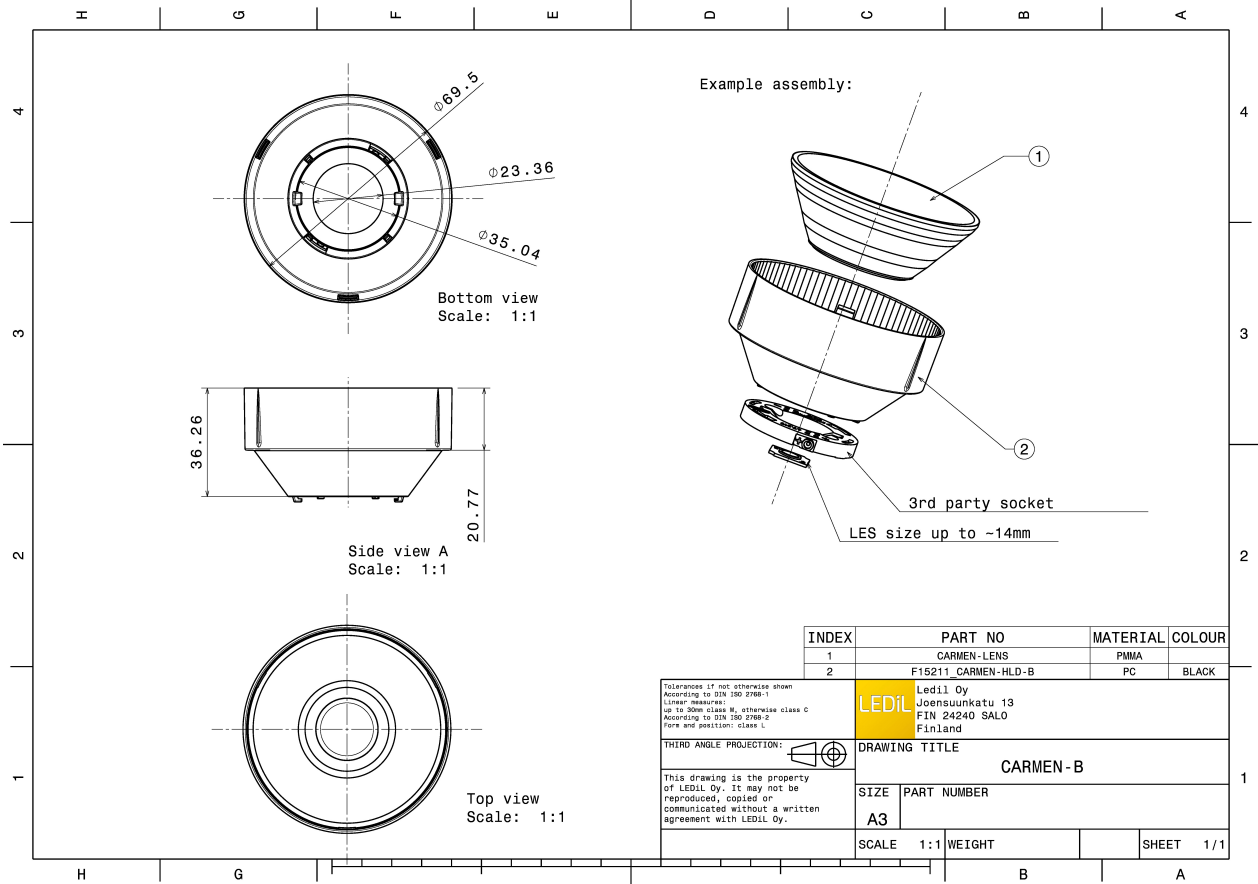

#### ORDERING INFORMATION:

Component		Qty in box	MOQ	MPQ	Box weight (kg)
CP15313_CARMEN-W-B	Single lens	150	150	15	6.0
» Box size: 476 x 273 x 292 mm					

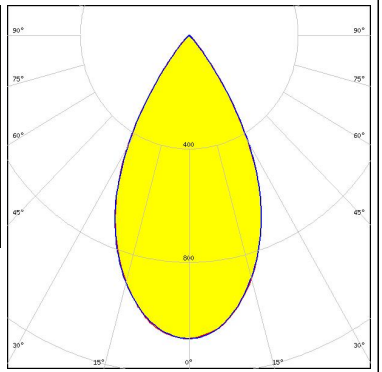

See also our general installation guide: [www.ledil.com/installation\\_guide](http://www.ledil.com/installation_guide)

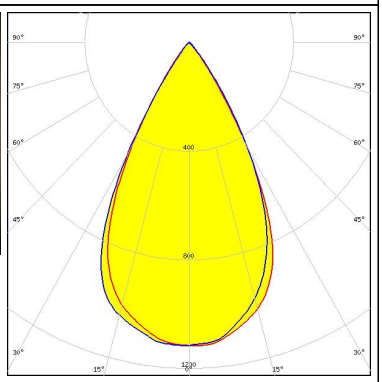
### OPTICAL RESULTS (MEASURED):

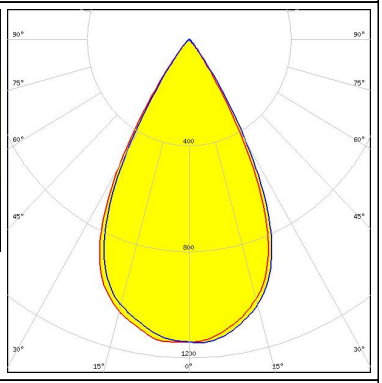
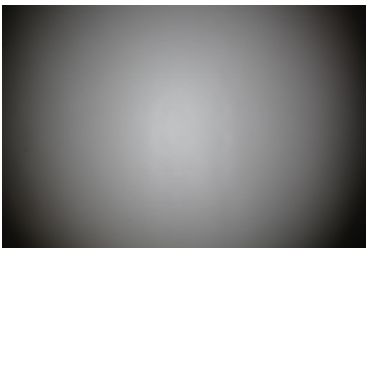
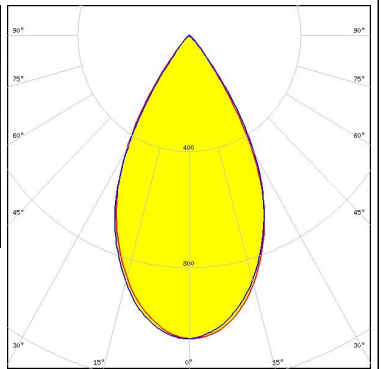
<p><b>bridgelux</b></p> <p>LED V10 Gen7            FWHM / FWTM 55.0° / 79.0°            Efficiency 81 %            Peak intensity 1.1 cd/lm            LEDs/each optic 1            Light colour White            Required components:            BJB: 47.319.6060</p>		
<p><b>CITIZEN</b></p> <p>LED CLU700/701/702/703            FWHM / FWTM 56.0° / 75.0°            Efficiency 86 %            Peak intensity 1.1 cd/lm            LEDs/each optic 1            Light colour White            Required components:            BJB: 47.319.6060</p>		
<p><b>CREE LEDs</b></p> <p>LED CXA/B 13xx            FWHM / FWTM 57.0° / 74.0°            Efficiency 89 %            Peak intensity 1.1 cd/lm            LEDs/each optic 1            Light colour White            Required components:</p>		
<p><b>SAMSUNG</b></p> <p>LED LC003D / LC006D / LC009D / LC013D            FWHM / FWTM 56.0° / 78.0°            Efficiency 82 %            Peak intensity 1 cd/lm            LEDs/each optic 1            Light colour White            Required components:            A.A.G. STUCCHI: 8100-G2</p>		

**OPTICAL RESULTS (MEASURED):**

## SAMSUNG

LED LC003D / LC006D / LC009D / LC013D  
 FWHM / FWTM 56.0° / 78.0°  
 Efficiency 82 %  
 Peak intensity 1 cd/lm  
 LEDs/each optic 1  
 Light colour White  
 Required components:  
 BJB: 47.319.6060

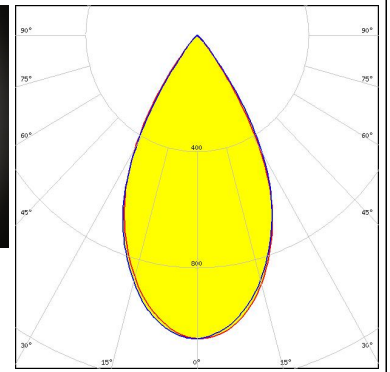

SEOUL SEMICONDUCTOR

LED MJT COB LES 6  
 FWHM / FWTM 55.0° / 75.0°  
 Efficiency 84 %  
 Peak intensity 1.1 cd/lm  
 LEDs/each optic 1  
 Light colour White  
 Required components:  
 BJB: 47.319.6060

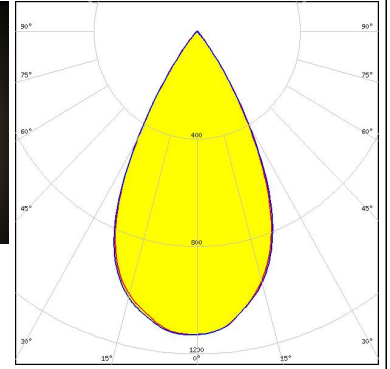

#### OPTICAL RESULTS (SIMULATED):

### CITIZEN

LED CLL02x/CLU02x (LES10)  
 FWHM / FWTM 55.0° / 75.0°  
 Efficiency 73 %  
 Peak intensity 1 cd/lm  
 LEDs/each optic 1  
 Light colour White  
 Required components:

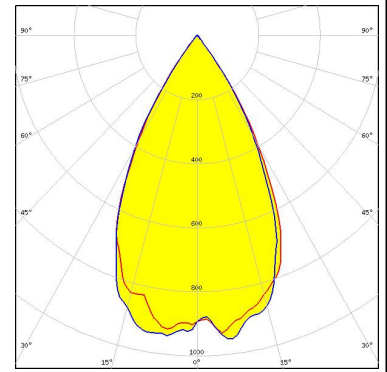

### CITIZEN

LED CLL02x/CLU02x (LES10)  
 FWHM / FWTM 55.0° / 74.0°  
 Efficiency 82 %  
 Peak intensity 1.2 cd/lm  
 LEDs/each optic 1  
 Light colour White  
 Required components:  
 BJB: 47.319.6060

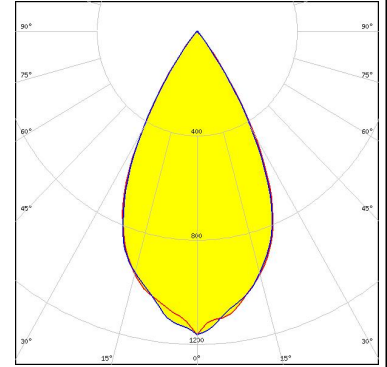

LED CXA/B 15xx  
 FWHM / FWTM 53.0° / 73.0°  
 Efficiency 73 %  
 Peak intensity 1 cd/lm  
 LEDs/each optic 1  
 Light colour White  
 Required components:

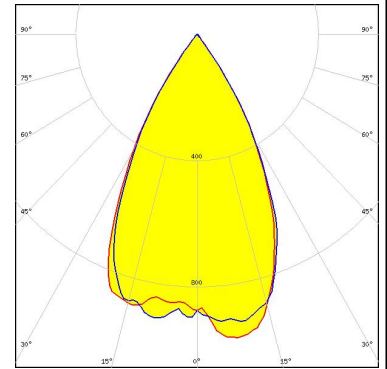

### GENERAL INFORMATION:

NOTE: The typical beam angle will be changed by different color, chip size and chip position tolerance. The typical total beam angle is the full angle measured where the luminous intensity is half of the peak value.

Due to use of high power COB's with this product, special attention to proper thermal design is highly recommended. LEDiL has no liability for direct, indirect or consecutive damages arising from the LEDiL products being used outside of the recommended temperature range.

### MATERIALS:

As part of our continuous research and improvement processes, and to ensure the best possible quality and availability of our products, LEDiL reserves the right to change material grades without notice.

### PRODUCT DATA USER AGREEMENT AND DISCLAIMER:

The measured data in the provided downloadable LEDiL Product Datasheets and Mechanical 2D-Drawings is rounded and provided as reference for planning. LEDiL Oy's optical specifications have been verified by conducting performance testing of the products in accordance with the company's quality system. The reported data are averaged results of multiple measurements with typical variation. LEDiL Oy reserves the right to without prior notification make changes and improvements to its products.

LEDiL Oy assumes neither warranty, nor guarantee nor any other liability of any kind for the contents and correctness of the provided data. The provided data has been generated with highest diligence but the provided data may in reality not represent the complete possible variation range of all intrinsic parameters. Therefore, in certain cases a deviation from the provided data could occur.

LEDiL Oy reserves the right to undertake technical changes of its products without further notification which could lead to changes in the provided data. LEDiL Oy assumes no liability of any kind for the possible deviation from any provided data or any other damage resulting from the usage of the provided data.

The user agrees to this disclaimer and user agreement with the download or usage of the provided files.

#### LEDiL Oy

Joensuunkatu 13  
FI-24240 SALO  
Finland

#### LEDiL Inc.

228 West Page Street  
Suite D  
Sycamore IL 60178  
USA

#### Ledil Optics Technology (Shenzhen) Co., Ltd.

# 405 , Block B  
Casic Motor Building  
Shenzhen 518057  
P.R.CHINA

#### Local sales and technical support

[www.ledil.com/  
where\\_to\\_buy](http://www.ledil.com/where_to_buy)

#### Shipping locations

Salo, Finland  
Hong Kong, China

#### Distribution Partners

[www.ledil.com/  
where\\_to\\_buy](http://www.ledil.com/where_to_buy)