

## AMY-70-RS

~13° spot beam with tight cutoff

### SPECIFICATION:

|                |           |
|----------------|-----------|
| Dimensions     | Ø 69.9 mm |
| Height         | 11.8 mm   |
| Fastening      | socket    |
| ROHS compliant | yes ⓘ     |

### MATERIALS:

| Component         | Type        | Material | Colour | Finish |
|-------------------|-------------|----------|--------|--------|
| AMY-70-RS         | Single lens | PMMA     | clear  |        |
| AMY-70-HLD2-C     | Holder C    | PC       | black  |        |
| AMY-70-HLD2-B     | Holder B    | PC       | black  |        |
| AMY-70-HLD2-C-WHT | Holder C    | PC       | white  |        |
| AMY-70-HLD2-B-WHT | Holder B    | PC       | white  |        |



### ORDERING INFORMATION:

| Component                | Qty in box | MOQ | MPQ | Box weight (kg) |
|--------------------------|------------|-----|-----|-----------------|
| C18516_AMY-70-RS         | 285        | 285 | 15  | 9.7             |
| <b>Assembly</b>          |            |     |     |                 |
| CP19121_AMY-70-RS-B2-WHT | 210        | 210 | 15  | 9.0             |
| CP19112_AMY-70-RS-C2-WHT | 210        | 210 | 15  | 8.8             |
| CP19105_AMY-70-RS-B2     | 210        | 210 | 15  | 9.0             |
| CP19045_AMY-70-RS-C2     | 210        | 210 | 15  | 8.8             |

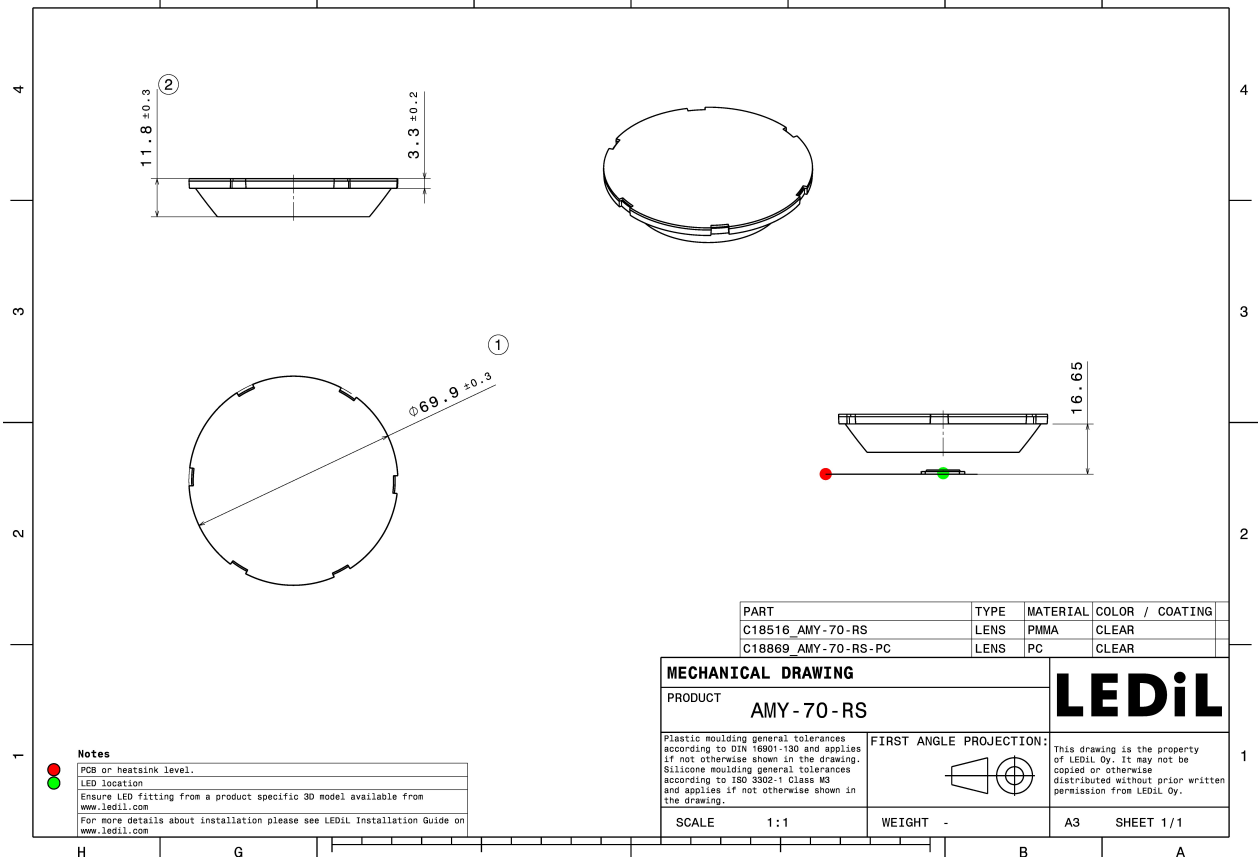
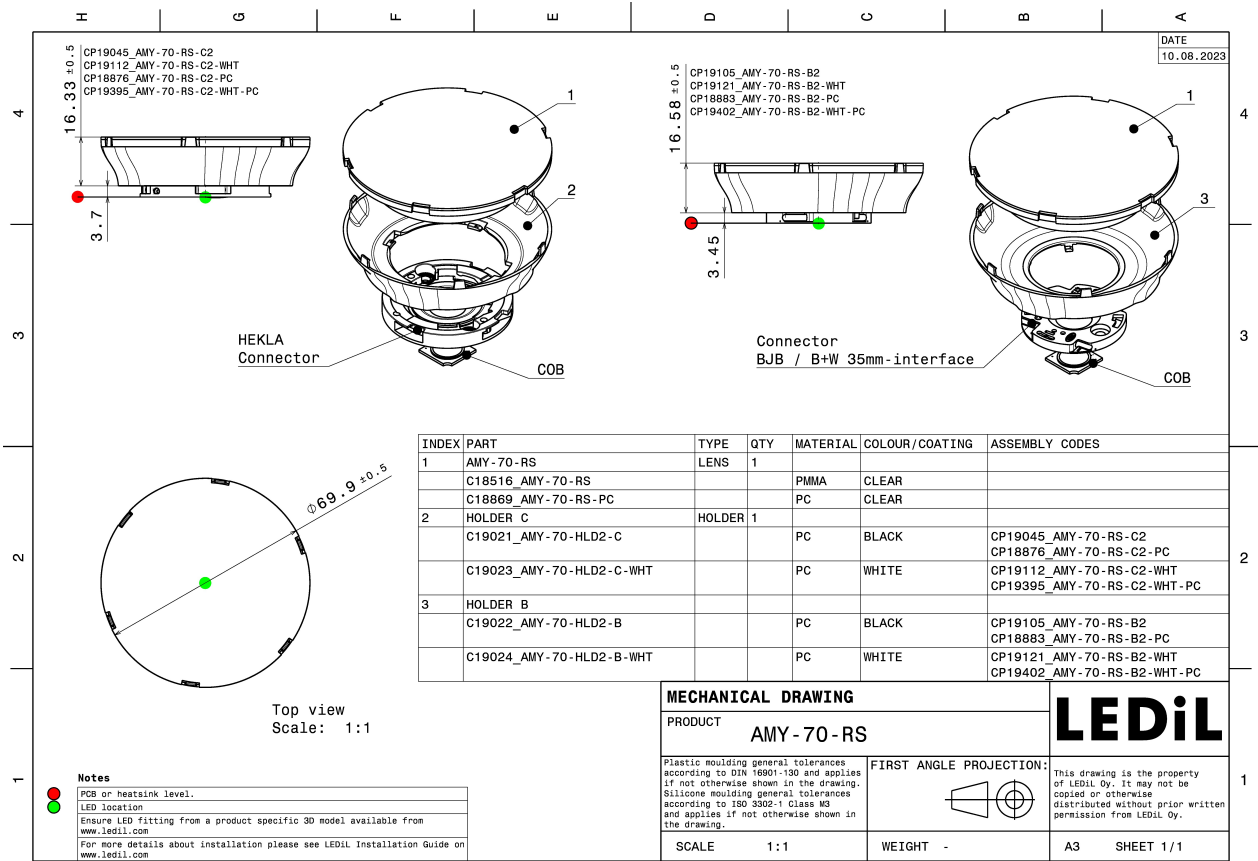

See also our general installation guide: [www.ledil.com/installation\\_guide](http://www.ledil.com/installation_guide)

### OPTICAL RESULTS (SIMULATED):

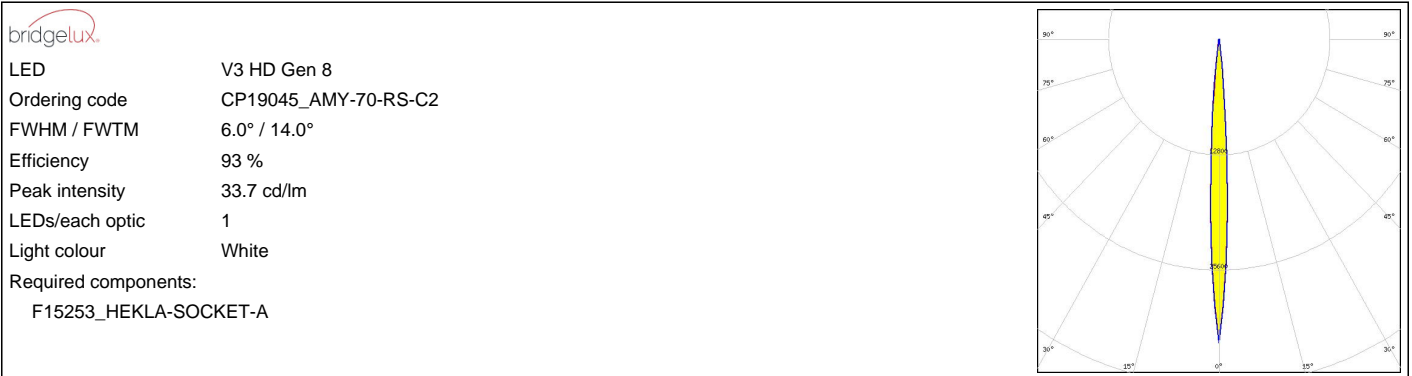

### OPTICAL RESULTS (SIMULATED):

bridgelux

LED V6 Gen 8-9  
 Ordering code CP19045\_AMY-70-RS-C2  
 FWHM / FWTM 10.0° / 18.0°  
 Efficiency 95 %  
 Peak intensity 18.2 cd/lm  
 LEDs/each optic 1  
 Light colour White  
 Required components:  
 F15253\_HEKLA-SOCKET-A

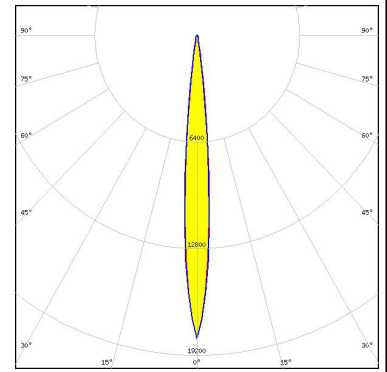

bridgelux

LED V6 Gen 8-9  
 Ordering code CP19045\_AMY-70-RS-C2  
 FWHM / FWTM 10.0° / 18.0°  
 Efficiency 92 %  
 Peak intensity 18.2 cd/lm  
 LEDs/each optic 1  
 Light colour White  
 Required components:  
 F15253\_HEKLA-SOCKET-A

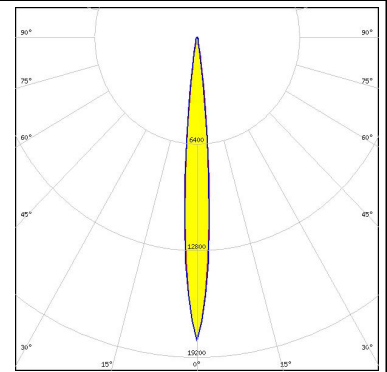

bridgelux

LED V6 HD Gen 8  
 Ordering code CP19045\_AMY-70-RS-C2  
 FWHM / FWTM 10.0° / 18.0°  
 Efficiency 91 %  
 Peak intensity 17.8 cd/lm  
 LEDs/each optic 1  
 Light colour White  
 Required components:  
 F15255\_HEKLA-SOCKET-C

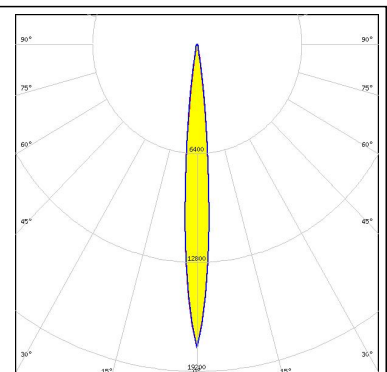

bridgelux

LED V9 HD Gen 8  
 Ordering code CP19045\_AMY-70-RS-C2  
 FWHM / FWTM 12.0° / 22.0°  
 Efficiency 90 %  
 Peak intensity 12.2 cd/lm  
 LEDs/each optic 1  
 Light colour White  
 Required components:  
 F15859\_HEKLA-SOCKET-I

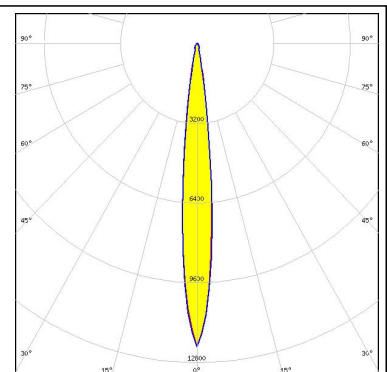

### OPTICAL RESULTS (SIMULATED):

bridgelux

LED VERO18  
 Ordering code CP19045\_AMY-70-RS-C2  
 FWHM / FWTM 28.0° / 56.0°  
 Efficiency 86 %  
 Peak intensity 2.5 cd/lm  
 LEDs/each optic 1  
 Light colour White  
 Required components:  
 C16142\_HEKLA-SOCKET-K

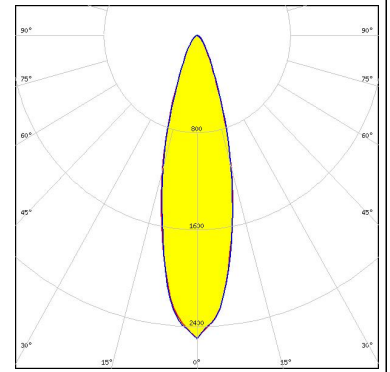

bridgelux

LED Vesta DTW 13mm (21W)  
 Ordering code CP19045\_AMY-70-RS-C2  
 FWHM / FWTM 10.0° / 20.0°  
 Efficiency 91 %  
 Peak intensity 15.7 cd/lm  
 LEDs/each optic 1  
 Light colour White  
 Required components:  
 Bender Wirth: 632b Hekla XL

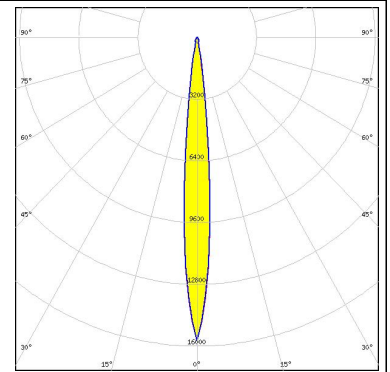

bridgelux

LED Vesta DTW 15mm (33W)  
 Ordering code CP19045\_AMY-70-RS-C2  
 FWHM / FWTM 20.0° / 40.0°  
 Efficiency 87 %  
 Peak intensity 4.7 cd/lm  
 LEDs/each optic 1  
 Light colour White  
 Required components:  
 Bender Wirth: 632b Hekla XL

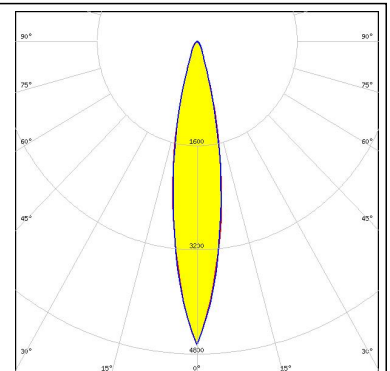

bridgelux

LED Vesta DTW 6mm  
 Ordering code CP19045\_AMY-70-RS-C2  
 FWHM / FWTM 10.0° / 20.0°  
 Efficiency 91 %  
 Peak intensity 15.3 cd/lm  
 LEDs/each optic 1  
 Light colour White  
 Required components:  
 Bender Wirth: 652b Hekla

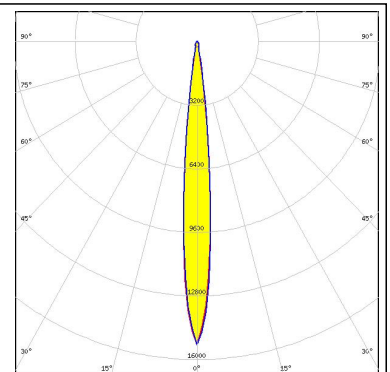

### OPTICAL RESULTS (SIMULATED):



**LED** Vesta SE 13mm TW  
**Ordering code** CP19045\_AMY-70-RS-C2  
**FWHM / FWTM** 20.0° / 37.0°  
**Efficiency** 82 %  
**Peak intensity** 4.7 cd/lm  
**LEDs/each optic** 1  
**Light colour** Tunable White  
**Required components:**  
 C16142\_HEKLA-SOCKET-K

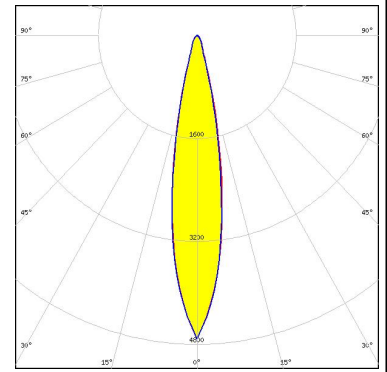

**LED** Vesta TW 13mm (18W) DP  
**Ordering code** CP19045\_AMY-70-RS-C2  
**FWHM / FWTM** 23.0° / 46.0°  
**Efficiency** 85 %  
**Peak intensity** 3.3 cd/lm  
**LEDs/each optic** 1  
**Light colour** White  
**Required components:**  
 C16142\_HEKLA-SOCKET-K  
 F18158\_HEKLA-RZ-LENS  
 Bender Wirth: 492 Typ L8

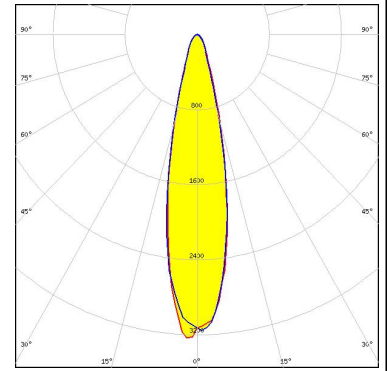

**LED** Vesta TW 9mm (9W) DP  
**Ordering code** CP19045\_AMY-70-RS-C2  
**FWHM / FWTM** 15.0° / 29.0°  
**Efficiency** 92 %  
**Peak intensity** 7.5 cd/lm  
**LEDs/each optic** 1  
**Light colour** White  
**Required components:**  
 C16142\_HEKLA-SOCKET-K  
 Bender Wirth: 489 Typ L8

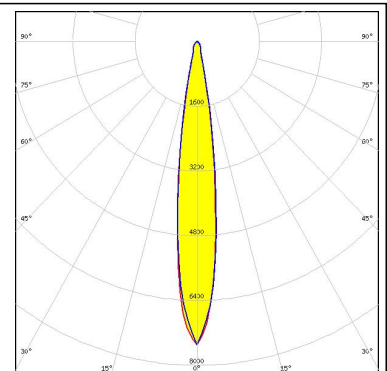

### CITIZEN

**LED** CLL02x/CLU02x (LES10)  
**Ordering code** CP19105\_AMY-70-RS-B2  
**FWHM / FWTM** 14.0° / 26.0°  
**Efficiency** 86 %  
**Peak intensity** 9 cd/lm  
**LEDs/each optic** 1  
**Light colour** White  
**Required components:**

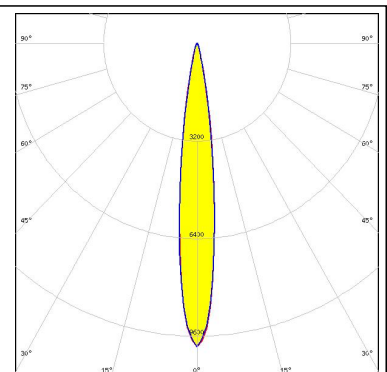

### OPTICAL RESULTS (SIMULATED):

#### CITIZEN

LED CLL02x/CLU02x (LES10)  
 Ordering code C18516\_AMY-70-RS  
 FWHM / FWTM 14.0° / 26.0°  
 Efficiency 86 %  
 Peak intensity 9 cd/lm  
 LEDs/each optic 1  
 Light colour White  
 Required components:

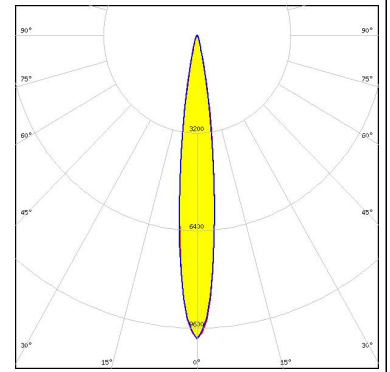

#### CITIZEN

LED CLL02x/CLU02x (LES10)  
 Ordering code CP19045\_AMY-70-RS-C2  
 FWHM / FWTM 14.0° / 26.0°  
 Efficiency 86 %  
 Peak intensity 9 cd/lm  
 LEDs/each optic 1  
 Light colour White  
 Required components:

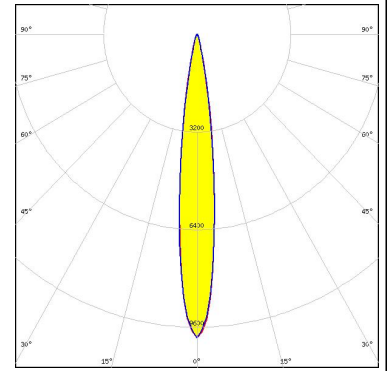

LED CHA0304  
 Ordering code CP19112\_AMY-70-RS-C2-WHT  
 FWHM / FWTM 6.0° / 12.0°  
 Efficiency 94 %  
 Peak intensity 39.7 cd/lm  
 LEDs/each optic 1  
 Light colour White  
 Required components:  
 F17435\_HEKLA-G2-C

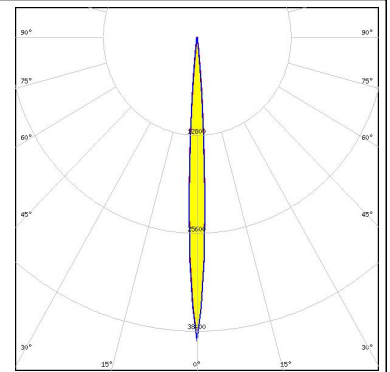

LED CHA0410  
 Ordering code CP19112\_AMY-70-RS-C2-WHT  
 FWHM / FWTM 8.0° / 14.0°  
 Efficiency 94 %  
 Peak intensity 29.7 cd/lm  
 LEDs/each optic 1  
 Light colour White  
 Required components:  
 F17435\_HEKLA-G2-C

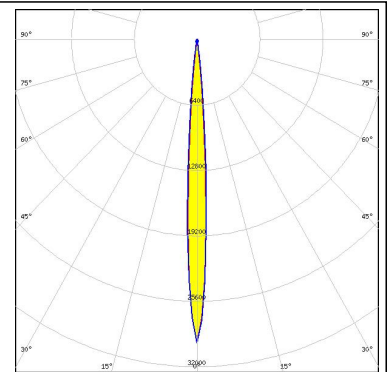



### OPTICAL RESULTS (SIMULATED):



**LED** CMA1840  
**Ordering code** CP19045\_AMY-70-RS-C2  
**FWHM / FWTM** 20.0° / 39.0°  
**Efficiency** 85 %  
**Peak intensity** 4.3 cd/lm  
**LEDs/each optic** 1  
**Light colour** White  
**Required components:**  
 Bender Wirth: 637a Hekla

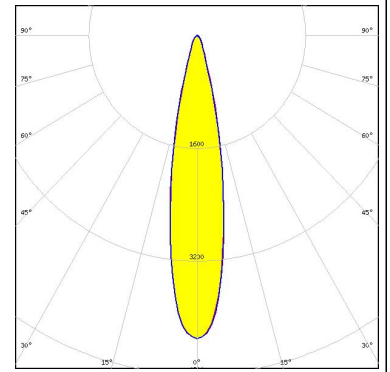

**LED** CMT14xx  
**Ordering code** CP19045\_AMY-70-RS-C2  
**FWHM / FWTM** 14.0° / 26.0°  
**Efficiency** 87 %  
**Peak intensity** 9.2 cd/lm  
**LEDs/each optic** 1  
**Light colour** White  
**Required components:**  
 F17435\_HEKLA-G2-C

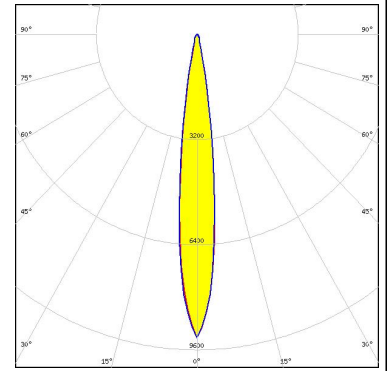

**LED** CMT14xx  
**Ordering code** C18516\_AMY-70-RS  
**FWHM / FWTM** 14.0° / 25.0°  
**Efficiency** 93 %  
**Peak intensity** 9.8 cd/lm  
**LEDs/each optic** 1  
**Light colour** White  
**Required components:**

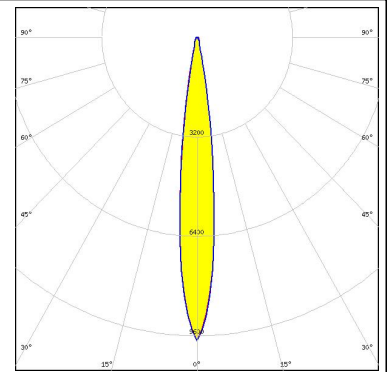

**LED** CMU10xx  
**Ordering code** CP19105\_AMY-70-RS-B2  
**FWHM / FWTM** 12.0° / 25.0°  
**Efficiency** 89 %  
**Peak intensity** 10 cd/lm  
**LEDs/each optic** 1  
**Light colour** White  
**Required components:**  
 BJB: 47.360.1020

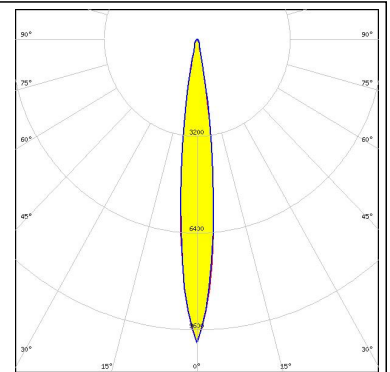

### OPTICAL RESULTS (SIMULATED):



**LED** CMU15xx  
**Ordering code** CP19045\_AMY-70-RS-C2  
**FWHM / FWTM** 20.0° / 38.0°  
**Efficiency** 85 %  
**Peak intensity** 4.6 cd/lm  
**LEDs/each optic** 1  
**Light colour** White  
**Required components:**  
 F17438\_HEKLA-G2-I

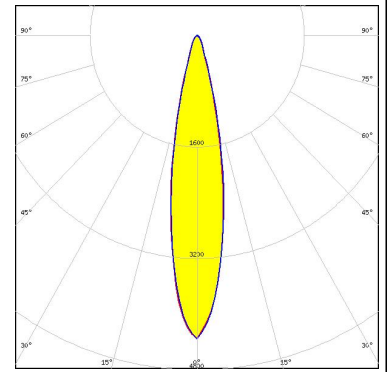

**LED** CMU15xx  
**Ordering code** CP19045\_AMY-70-RS-C2  
**FWHM / FWTM** 20.0° / 40.0°  
**Efficiency** 85 %  
**Peak intensity** 4.4 cd/lm  
**LEDs/each optic** 1  
**Light colour** White  
**Required components:**  
 Bender Wirth: 633a Hekla

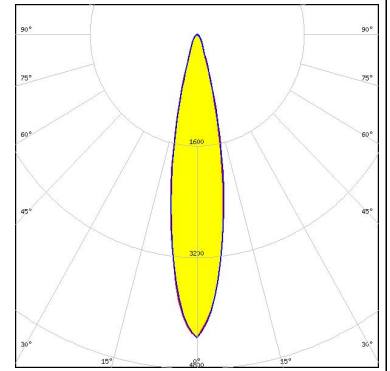

**LED** LUXEON CX Plus CoB L08 (Gen2)  
**Ordering code** CP19045\_AMY-70-RS-C2  
**FWHM / FWTM** 22.0° / 40.0°  
**Efficiency** 89 %  
**Peak intensity** 4.2 cd/lm  
**LEDs/each optic** 1  
**Light colour** White  
**Required components:**  
 Bender Wirth: 637a Hekla

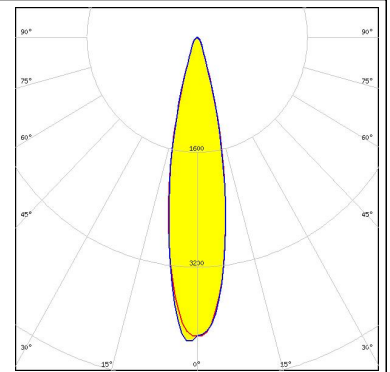

**LED** LUXEON 7070  
**FWHM / FWTM** 9.0° / 18.0°  
**Efficiency** 94 %  
**Peak intensity** 19.8 cd/lm  
**LEDs/each optic** 1  
**Light colour** White  
**Required components:**

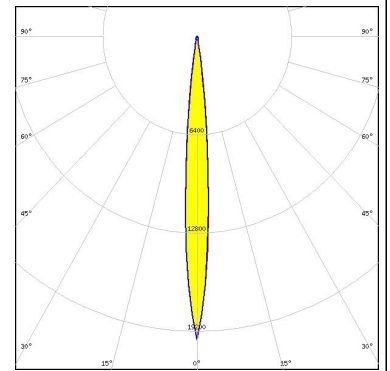

### OPTICAL RESULTS (SIMULATED):

#### LUMILEDS

LED LUXEON CoB 1202/1203  
 Ordering code CP19045\_AMY-70-RS-C2  
 FWHM / FWTM 12.0° / 24.0°  
 Efficiency 90 %  
 Peak intensity 10.8 cd/lm  
 LEDs/each optic 1  
 Light colour White  
 Required components:  
 F15858\_HEKLA-SOCKET-H

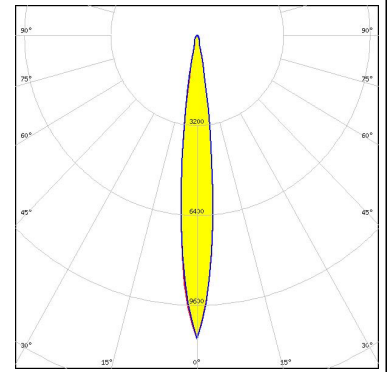

#### LUMILEDS

LED LUXEON CoB 1202HD  
 Ordering code CP19045\_AMY-70-RS-C2  
 FWHM / FWTM 10.0° / 20.0°  
 Efficiency 92 %  
 Peak intensity 16.2 cd/lm  
 LEDs/each optic 1  
 Light colour White  
 Required components:  
 F15848\_HEKLA-SOCKET-G

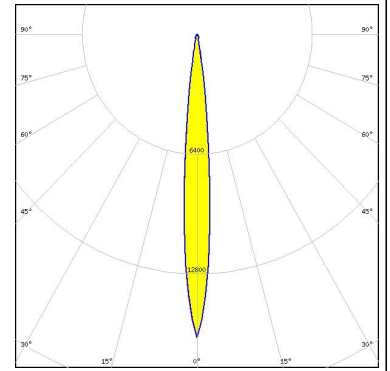

#### LUMILEDS

LED LUXEON CoB 1204/1205  
 Ordering code CP19045\_AMY-70-RS-C2  
 FWHM / FWTM 20.0° / 36.0°  
 Efficiency 88 %  
 Peak intensity 5.2 cd/lm  
 LEDs/each optic 1  
 Light colour White  
 Required components:  
 Bender Wirth: 632a Hekla XL

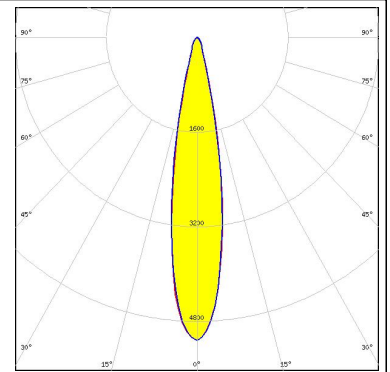

#### LUMILEDS

LED LUXEON CoB 1204HD  
 Ordering code CP19045\_AMY-70-RS-C2  
 FWHM / FWTM 14.0° / 25.0°  
 Efficiency 90 %  
 Peak intensity 9.7 cd/lm  
 LEDs/each optic 1  
 Light colour White  
 Required components:  
 F15858\_HEKLA-SOCKET-H

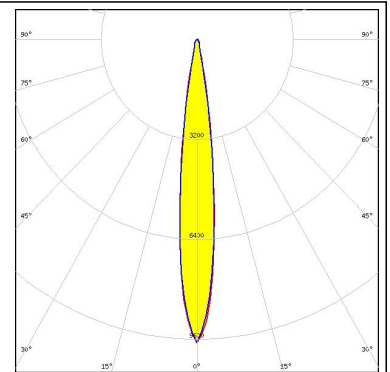

### OPTICAL RESULTS (SIMULATED):

#### LUMILEDS

LED LUXEON CoB 1205HD  
 Ordering code CP19045\_AMY-70-RS-C2  
 FWHM / FWTM 18.0° / 30.0°  
 Efficiency 89 %  
 Peak intensity 6.5 cd/lm  
 LEDs/each optic 1  
 Light colour White  
 Required components:  
 F15858\_HEKLA-SOCKET-H

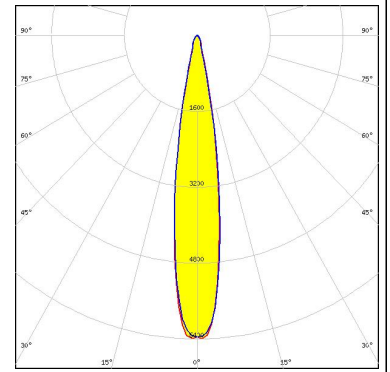

#### LUMILEDS

LED LUXEON CoB 1208  
 Ordering code CP19045\_AMY-70-RS-C2  
 FWHM / FWTM 21.0° / 40.0°  
 Efficiency 88 %  
 Peak intensity 4.3 cd/lm  
 LEDs/each optic 1  
 Light colour White  
 Required components:  
 Bender Wirth: 632a Hekla XL

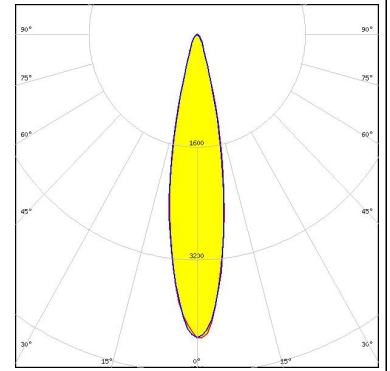

#### LUMILEDS

LED LUXEON CX Plus CoB - HD S02H6  
 Ordering code CP19105\_AMY-70-RS-B2  
 FWHM / FWTM 10.0° / 19.0°  
 Efficiency 92 %  
 Peak intensity 17.6 cd/lm  
 LEDs/each optic 1  
 Light colour White  
 Required components:  
 Bender Wirth: 634c Bayonet35L

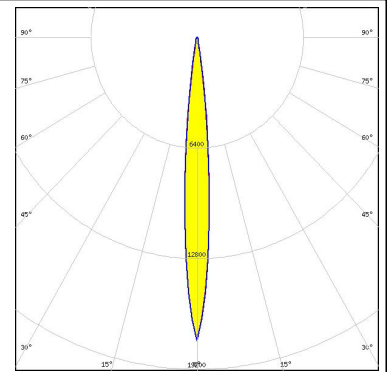

#### LUMILEDS

LED LUXEON CX Plus CoB - HD S04H9  
 Ordering code CP19105\_AMY-70-RS-B2  
 FWHM / FWTM 14.0° / 26.0°  
 Efficiency 91 %  
 Peak intensity 9.2 cd/lm  
 LEDs/each optic 1  
 Light colour White  
 Required components:  
 Bender Wirth: 634a Bayonet35L

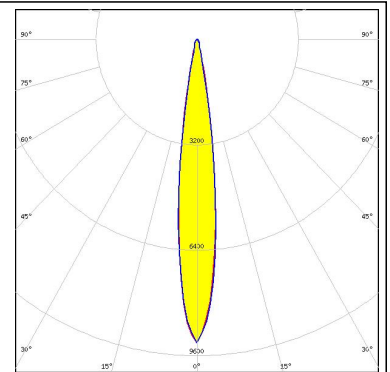

### OPTICAL RESULTS (SIMULATED):

#### LUMILEDS

LED LUXEON CX Plus CoB L04 / L05 (Gen2)  
 Ordering code CP19045\_AMY-70-RS-C2  
 FWHM / FWTM 16.0° / 32.0°  
 Efficiency 89 %  
 Peak intensity 6.5 cd/lm  
 LEDs/each optic 1  
 Light colour White  
 Required components:  
 F15254\_HEKLA-SOCKET-B

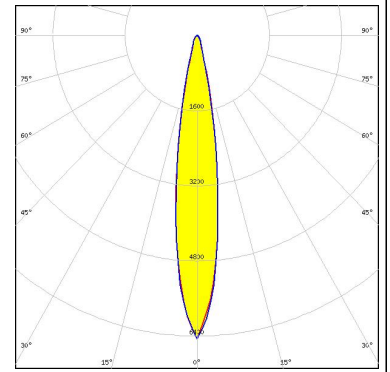

#### LUMILEDS

LED LUXEON CX Plus CoB M02 / M03 (Gen2)  
 Ordering code CP19045\_AMY-70-RS-C2  
 FWHM / FWTM 14.0° / 26.0°  
 Efficiency 91 %  
 Peak intensity 9.8 cd/lm  
 LEDs/each optic 1  
 Light colour White  
 Required components:  
 F15256\_HEKLA-SOCKET-D

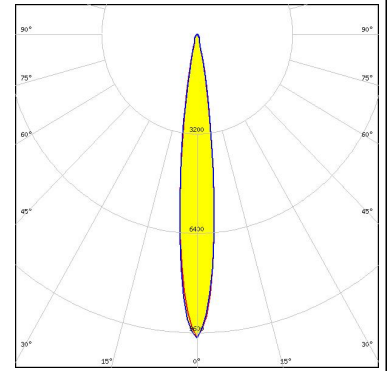

#### LUMILEDS

LED LUXEON CX Plus CoB S01 (Gen2)  
 Ordering code CP19045\_AMY-70-RS-C2  
 FWHM / FWTM 10.0° / 18.0°  
 Efficiency 92 %  
 Peak intensity 18.8 cd/lm  
 LEDs/each optic 1  
 Light colour White  
 Required components:  
 F15956\_HEKLA-SOCKET-J

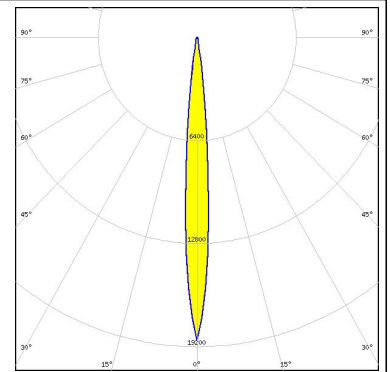

#### LUMINUS

LED CHM-9 XH (19x19)  
 Ordering code CP19045\_AMY-70-RS-C2  
 FWHM / FWTM 12.0° / 24.0°  
 Efficiency 91 %  
 Peak intensity 11.4 cd/lm  
 LEDs/each optic 1  
 Light colour White  
 Required components:  
 F15859\_HEKLA-SOCKET-I

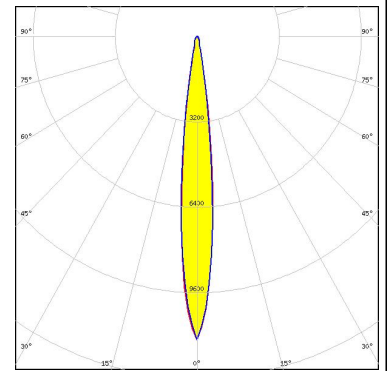

### OPTICAL RESULTS (SIMULATED):



**LED** CTM-14 (Tunable White) Gen2  
**Ordering code** CP19045\_AMY-70-RS-C2  
**FWHM / FWTM** 20.0° / 36.0°  
**Efficiency** 89 %  
**Peak intensity** 5.1 cd/lm  
**LEDs/each optic** 1  
**Light colour** Tunable White  
**Required components:**  
 C16142\_HEKLA-SOCKET-K  
 Bender Wirth: 442 Typ L8

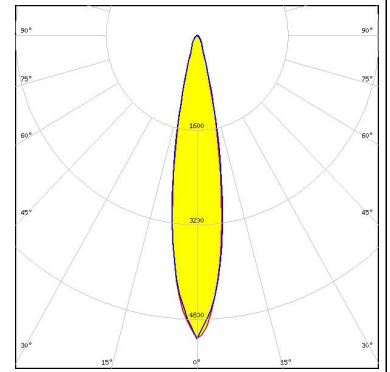

**LED** CTM-6 (Tunable White) Gen2  
**Ordering code** CP19045\_AMY-70-RS-C2  
**FWHM / FWTM** 10.0° / 20.0°  
**Efficiency** 92 %  
**Peak intensity** 16.2 cd/lm  
**LEDs/each optic** 1  
**Light colour** Tunable White  
**Required components:**  
 C16142\_HEKLA-SOCKET-K  
 Bender Wirth: 495 Typ L8

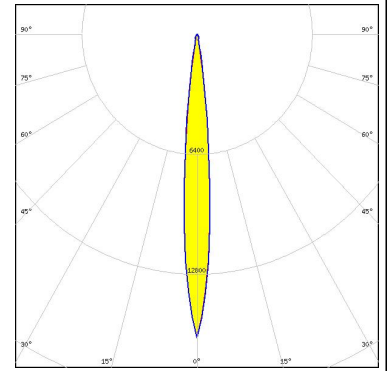

**LED** CTM-9 (Tunable White) Gen2  
**Ordering code** CP19045\_AMY-70-RS-C2  
**FWHM / FWTM** 12.0° / 24.0°  
**Efficiency** 90 %  
**Peak intensity** 10.6 cd/lm  
**LEDs/each optic** 1  
**Light colour** Tunable White  
**Required components:**  
 C16142\_HEKLA-SOCKET-K  
 Bender Wirth: 495 Typ L8

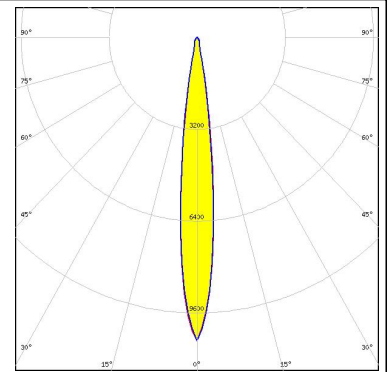

**LED** CxM-14 (18.5x18.5)  
**Ordering code** CP19045\_AMY-70-RS-C2  
**FWHM / FWTM** 22.0° / 41.0°  
**Efficiency** 86 %  
**Peak intensity** 4 cd/lm  
**LEDs/each optic** 1  
**Light colour** White  
**Required components:**  
 F17438\_HEKLA-G2-I

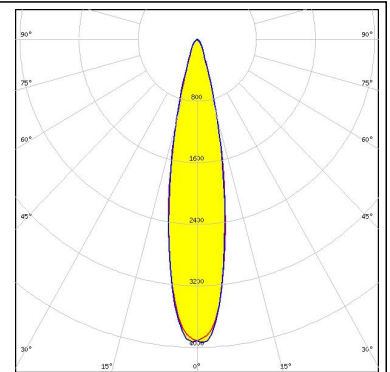

### OPTICAL RESULTS (SIMULATED):



**LED** CXM-3  
**Ordering code** CP19105\_AMY-70-RS-B2  
**FWHM / FWTM** 6.0° / 12.0°  
**Efficiency** 93 %  
**Peak intensity** 38 cd/lm  
**LEDs/each optic** 1  
**Light colour** White  
**Required components:**  
 Bender Wirth: 634a Bayonet35L

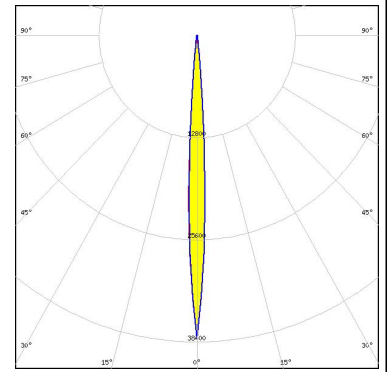

**LED** CXM-4  
**Ordering code** CP19105\_AMY-70-RS-B2  
**FWHM / FWTM** 8.0° / 15.0°  
**Efficiency** 92 %  
**Peak intensity** 27.9 cd/lm  
**LEDs/each optic** 1  
**Light colour** White  
**Required components:**  
 Bender Wirth: 634a Bayonet35L

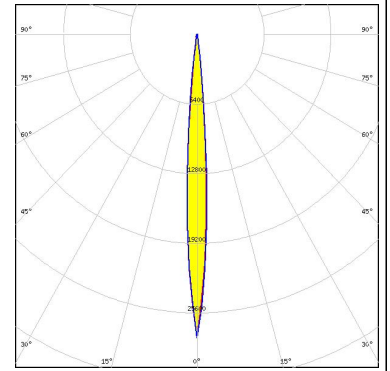

**LED** CxM-6 (13.5x13.5)  
**Ordering code** CP19105\_AMY-70-RS-B2  
**FWHM / FWTM** 10.0° / 18.0°  
**Efficiency** 92 %  
**Peak intensity** 18.2 cd/lm  
**LEDs/each optic** 1  
**Light colour** White  
**Required components:**  
 BJB: 47.360.1020

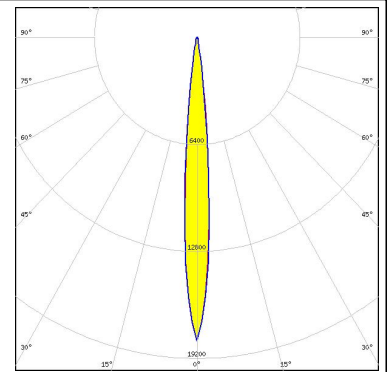

**LED** COB J-Type  
**Ordering code** CP19045\_AMY-70-RS-C2  
**FWHM / FWTM** 21.0° / 40.0°  
**Efficiency** 89 %  
**Peak intensity** 4.5 cd/lm  
**LEDs/each optic** 1  
**Light colour** White  
**Required components:**  
 Bender Wirth: 663a Hekla XL

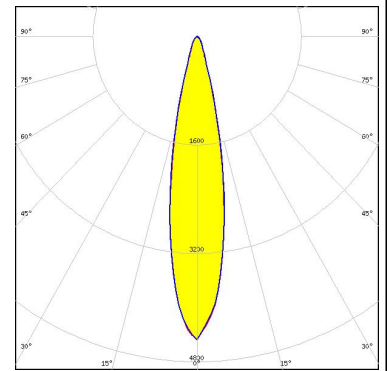

### OPTICAL RESULTS (SIMULATED):



**LED** COB L-Type (LES 11)  
**Ordering code** CP19045\_AMY-70-RS-C2  
**FWHM / FWTM** 16.0° / 30.0°  
**Efficiency** 90 %  
**Peak intensity** 7.1 cd/lm  
**LEDs/each optic** 1  
**Light colour** White  
**Required components:**  
 F15858\_HEKLA-SOCKET-H

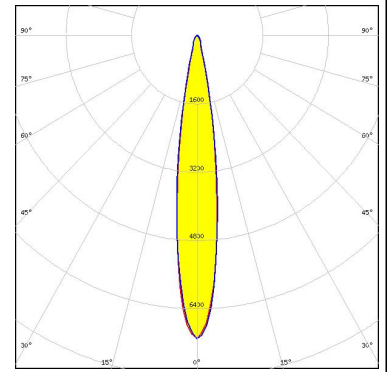

**LED** COB S-Type (LES 6)  
**Ordering code** CP19105\_AMY-70-RS-B2  
**FWHM / FWTM** 8.0° / 18.0°  
**Efficiency** 92 %  
**Peak intensity** 20.4 cd/lm  
**LEDs/each optic** 1  
**Light colour** White  
**Required components:**  
 Bender Wirth: 652a Bayonet35L

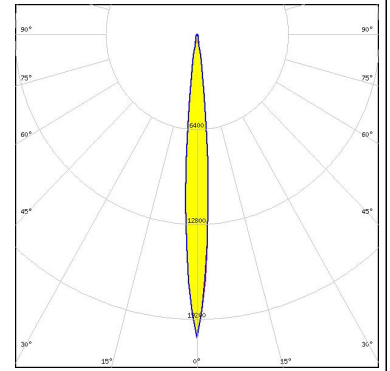

**LED** COB S-Type (LES 7)  
**Ordering code** CP19105\_AMY-70-RS-B2  
**FWHM / FWTM** 10.0° / 20.0°  
**Efficiency** 92 %  
**Peak intensity** 16.6 cd/lm  
**LEDs/each optic** 1  
**Light colour** White  
**Required components:**  
 Bender Wirth: 652a Bayonet35L

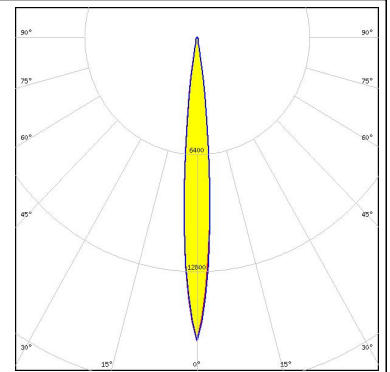

**LED** COB T-Type  
**Ordering code** CP19105\_AMY-70-RS-B2  
**FWHM / FWTM** 10.0° / 18.0°  
**Efficiency** 92 %  
**Peak intensity** 18.6 cd/lm  
**LEDs/each optic** 1  
**Light colour** White  
**Required components:**  
 Bender Wirth: 652a Bayonet35L

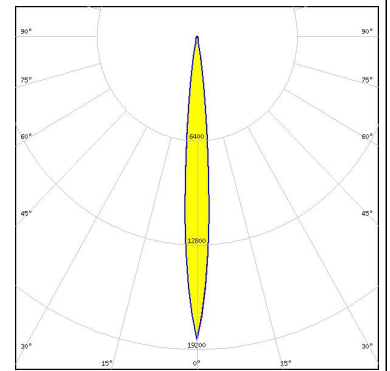



### OPTICAL RESULTS (SIMULATED):



**LED** NJCWL024Z-V1MT: COB L-Type Tunable White  
**Ordering code** CP19045\_AMY-70-RS-C2  
**FWHM / FWTM** 10.0° / 20.0°  
**Efficiency** 91 %  
**Peak intensity** 15.1 cd/lm  
**LEDs/each optic** 1  
**Light colour** Tunable White  
**Required components:**  
 C16142\_HEKLA-SOCKET-K  
 Bender Wirth: 497 Typ L8 HV

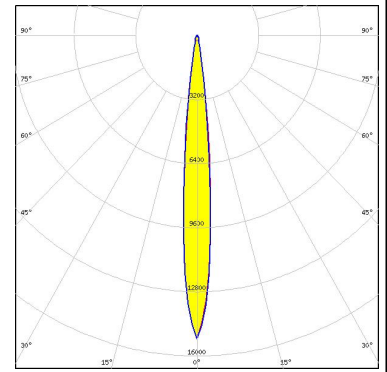

**LED** NJNWS012Z-V1MT: COB S-Type Tunable White  
**Ordering code** CP19045\_AMY-70-RS-C2  
**FWHM / FWTM** 8.0° / 16.0°  
**Efficiency** 92 %  
**Peak intensity** 23.8 cd/lm  
**LEDs/each optic** 1  
**Light colour** Tunable White  
**Required components:**  
 C16142\_HEKLA-SOCKET-K  
 Bender Wirth: 495 Typ L8 HV

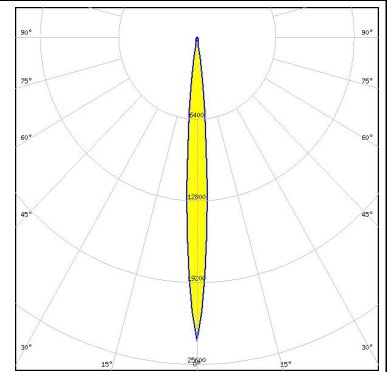

**LED** NVCWJ024Z-V1MT: COB J-Type Tunable White  
**Ordering code** CP19045\_AMY-70-RS-C2  
**FWHM / FWTM** 14.0° / 28.0°  
**Efficiency** 90 %  
**Peak intensity** 8.1 cd/lm  
**LEDs/each optic** 1  
**Light colour** Tunable White  
**Required components:**  
 C16142\_HEKLA-SOCKET-K  
 Bender Wirth: 498 Typ L8 HV

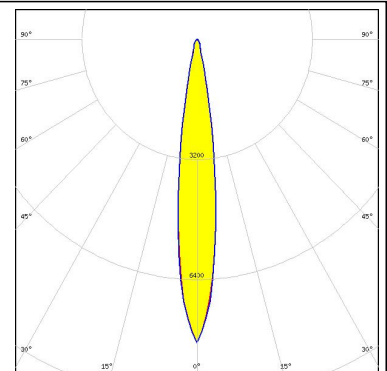

**LED** LC003D / LC006D / LC009D / LC013D  
**Ordering code** CP19105\_AMY-70-RS-B2  
**FWHM / FWTM** 14.0° / 26.0°  
**Efficiency** 91 %  
**Peak intensity** 9.8 cd/lm  
**LEDs/each optic** 1  
**Light colour** White  
**Required components:**  
 BJB: 47.360.1020

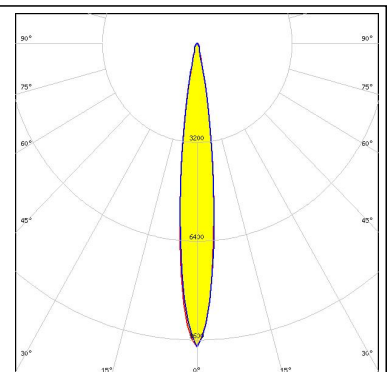

### OPTICAL RESULTS (SIMULATED):

#### SAMSUNG

LED LC010C G2  
 Ordering code CP19105\_AMY-70-RS-B2  
 FWHM / FWTM 10.0° / 18.0°  
 Efficiency 92 %  
 Peak intensity 19.3 cd/lm  
 LEDs/each optic 1  
 Light colour White  
 Required components:  
 BJB: 47.360.1020

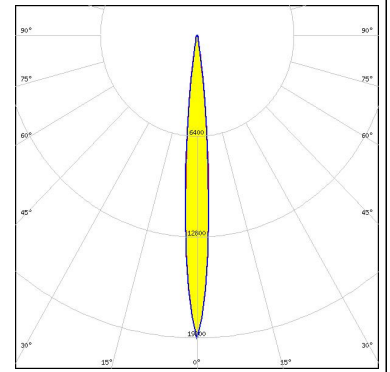

#### SAMSUNG

LED LC010T (Tunable White)  
 Ordering code CP19045\_AMY-70-RS-C2  
 FWHM / FWTM 12.0° / 22.0°  
 Efficiency 91 %  
 Peak intensity 12.9 cd/lm  
 LEDs/each optic 1  
 Light colour Tunable White  
 Required components:  
 Bender Wirth: 501 Typ L8

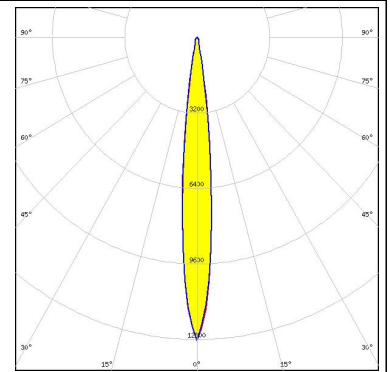

#### SAMSUNG

LED LC016D / LC019D / LC026D / LC033D  
 Ordering code CP19045\_AMY-70-RS-C2  
 FWHM / FWTM 20.0° / 40.0°  
 Efficiency 85 %  
 Peak intensity 4.3 cd/lm  
 LEDs/each optic 1  
 Light colour White  
 Required components:  
 F17438\_HEKLA-G2-I

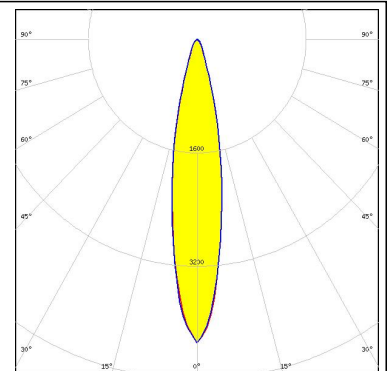

#### SAMSUNG

LED LC020C G2  
 Ordering code CP19105\_AMY-70-RS-B2  
 FWHM / FWTM 12.0° / 24.0°  
 Efficiency 90 %  
 Peak intensity 11.4 cd/lm  
 LEDs/each optic 1  
 Light colour White  
 Required components:  
 BJB: 47.360.1010

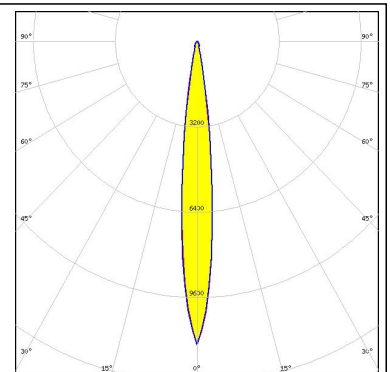

### OPTICAL RESULTS (SIMULATED):

#### SAMSUNG

LED LC020T (Tunable white)  
 Ordering code CP19045\_AMY-70-RS-C2  
 FWHM / FWTM 16.0° / 30.0°  
 Efficiency 90 %  
 Peak intensity 6.8 cd/lm  
 LEDs/each optic 1  
 Light colour Tunable White  
 Required components:  
 C16142\_HEKLA-SOCKET-K  
 Bender Wirth: 501 Typ L8

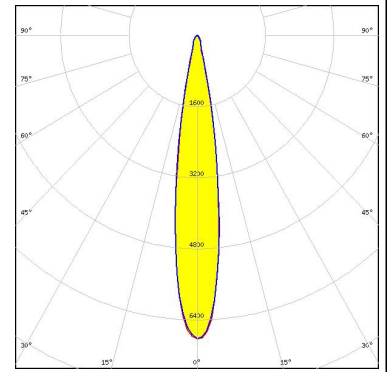

#### SAMSUNG

LED LC030C/040C G2  
 Ordering code CP19105\_AMY-70-RS-B2  
 FWHM / FWTM 16.0° / 32.0°  
 Efficiency 89 %  
 Peak intensity 6.7 cd/lm  
 LEDs/each optic 1  
 Light colour White  
 Required components:  
 BJB: 47.360.1010

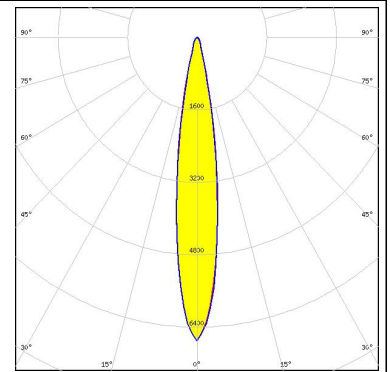

SEOUL SEMICONDUCTOR

LED MJT COB LES 14.5  
 Ordering code CP19045\_AMY-70-RS-C2  
 FWHM / FWTM 22.0° / 40.0°  
 Efficiency 88 %  
 Peak intensity 4.3 cd/lm  
 LEDs/each optic 1  
 Light colour White  
 Required components:  
 F15859\_HEKLA-SOCKET-I

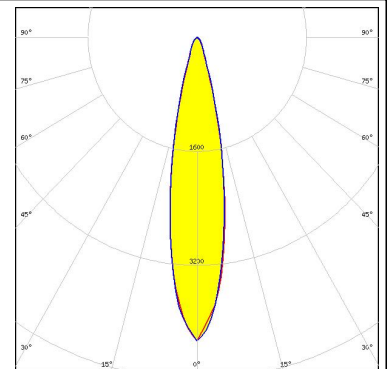

SEOUL SEMICONDUCTOR

LED MJT COB LES 6  
 Ordering code CP19045\_AMY-70-RS-C2  
 FWHM / FWTM 8.0° / 18.0°  
 Efficiency 93 %  
 Peak intensity 20.5 cd/lm  
 LEDs/each optic 1  
 Light colour White  
 Required components:  
 F15255\_HEKLA-SOCKET-C

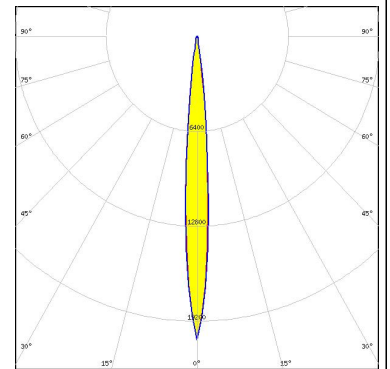

### OPTICAL RESULTS (SIMULATED):



### GENERAL INFORMATION:

NOTE: The typical beam angle will be changed by different color, chip size and chip position tolerance. The typical total beam angle is the full angle measured where the luminous intensity is half of the peak value.

Due to use of high power COB's with this product, special attention to proper thermal design is highly recommended. LEDiL has no liability for direct, indirect or consecutive damages arising from the LEDiL products being used outside of the recommended temperature range.

### MATERIALS:

As part of our continuous research and improvement processes, and to ensure the best possible quality and availability of our products, LEDiL reserves the right to change material grades without notice.

### PRODUCT DATA USER AGREEMENT AND DISCLAIMER:

The measured data in the provided downloadable LEDiL Product Datasheets and Mechanical 2D-Drawings is rounded and provided as reference for planning. LEDiL Oy's optical specifications have been verified by conducting performance testing of the products in accordance with the company's quality system. The reported data are averaged results of multiple measurements with typical variation. LEDiL Oy reserves the right to without prior notification make changes and improvements to its products.

LEDiL Oy assumes neither warranty, nor guarantee nor any other liability of any kind for the contents and correctness of the provided data. The provided data has been generated with highest diligence but the provided data may in reality not represent the complete possible variation range of all intrinsic parameters. Therefore, in certain cases a deviation from the provided data could occur.

LEDiL Oy reserves the right to undertake technical changes of its products without further notification which could lead to changes in the provided data. LEDiL Oy assumes no liability of any kind for the possible deviation from any provided data or any other damage resulting from the usage of the provided data.

The user agrees to this disclaimer and user agreement with the download or usage of the provided files.

#### LEDiL Oy

Joensuunkatu 13  
FI-24240 SALO  
Finland

#### LEDiL Inc.

228 West Page Street  
Suite D  
Sycamore IL 60178  
USA

#### Ledil Optics Technology (Shenzhen) Co., Ltd.

# 405 , Block B  
Casic Motor Building  
Shenzhen 518057  
P.R.CHINA

#### Local sales and technical support

[www.ledil.com/  
where\\_to\\_buy](http://www.ledil.com/where_to_buy)

#### Shipping locations

Salo, Finland  
Hong Kong, China

#### Distribution Partners

[www.ledil.com/  
where\\_to\\_buy](http://www.ledil.com/where_to_buy)