

AMY-110-W

~36° wide beam

SPECIFICATION:

Dimensions	Ø 109.7 mm
Height	17.3 mm
Fastening	socket
ROHS compliant	yes ⓘ

MATERIALS:

Component	Type	Material	Colour	Finish
AMY-110-W	Single lens	PMMA	clear	
AMY-110-HLD-C	Holder C	PC	black	
AMY-110-HLD-B	Holder B	PC	black	
AMY-110-HLD-C-WHT	Holder C	PC	white	
AMY-110-HLD-B-WHT	Holder B	PC	white	



ORDERING INFORMATION:

Component	Qty in box	MOQ	MPQ	Box weight (kg)
C18569_AMY-110-W	128	128	8	11.3
Assembly				
CP19034_AMY-110-W-B-WHT	77	77	7	8.4
CP19030_AMY-110-W-C-WHT	77	77	7	0.0
CP18577_AMY-110-W-B	77	77	7	8.3
CP18573_AMY-110-W-C	77	77	7	8.6

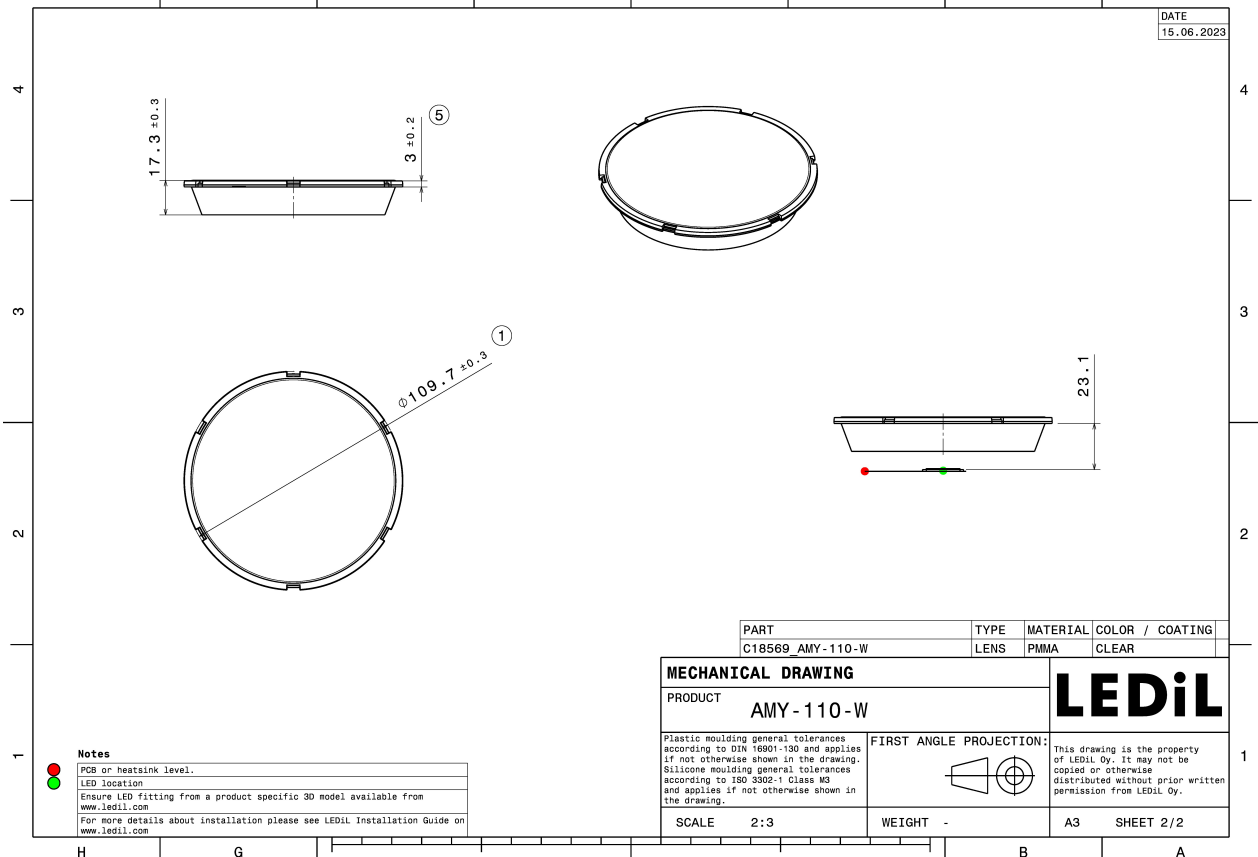
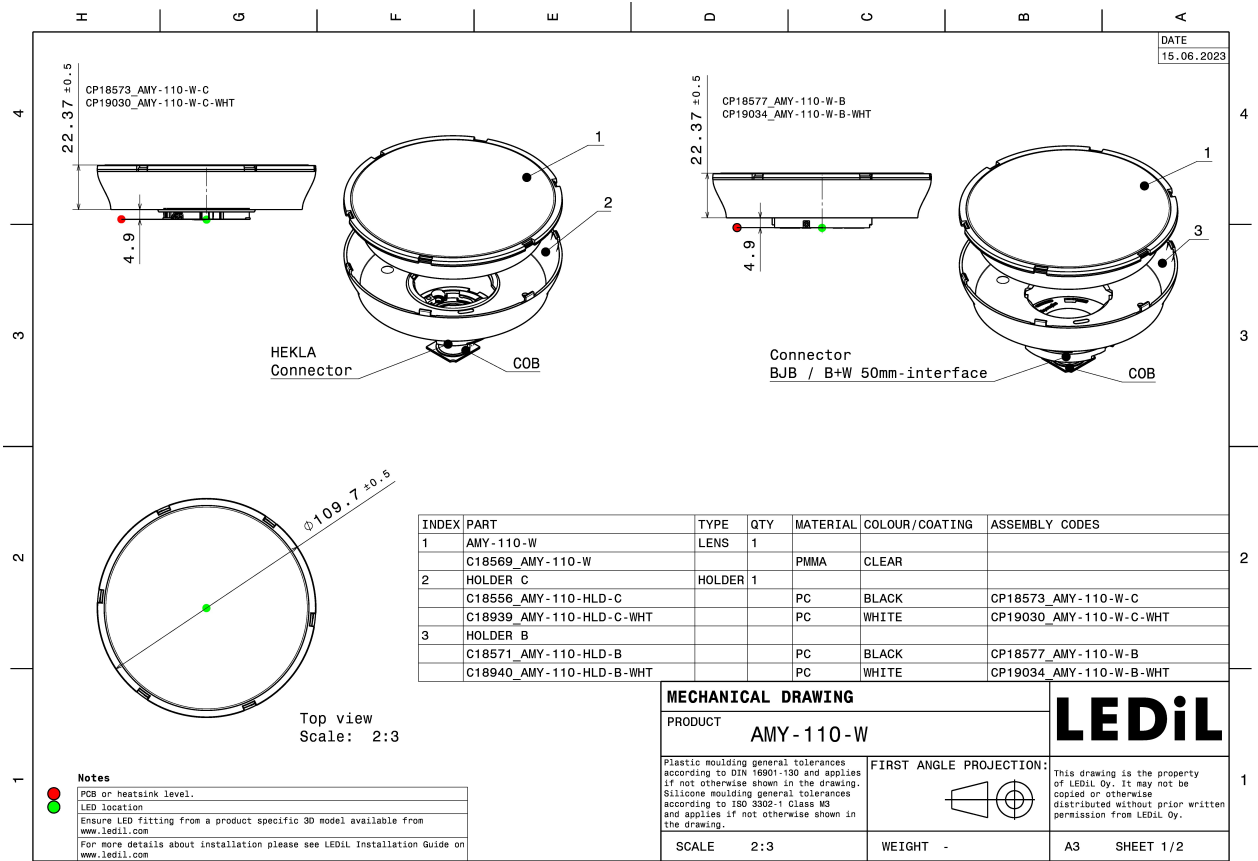

See also our general installation guide: www.ledil.com/installation_guide

OPTICAL RESULTS (MEASURED):

CITIZEN

LED LCN-C07A
 Ordering code C18569_AMY-110-W
 FWHM / FWTM 37.0° / 76.0°
 Efficiency 86 %
 LEDs/each optic 1
 Light colour White
 Required components:

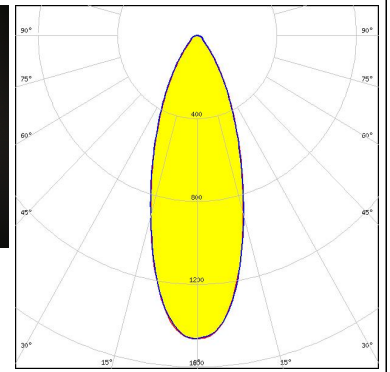
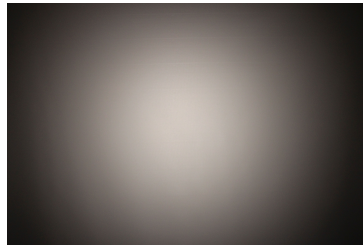

CITIZEN

LED LCN-C08A
 Ordering code C18569_AMY-110-W
 FWHM / FWTM 38.0° / 84.0°
 Efficiency 85 %
 LEDs/each optic 1
 Light colour White
 Required components:

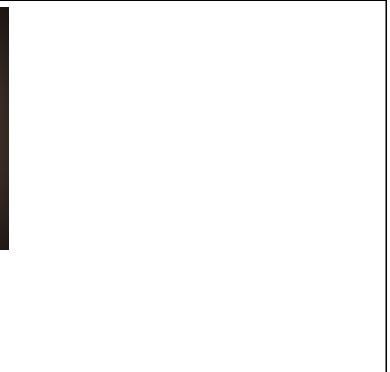
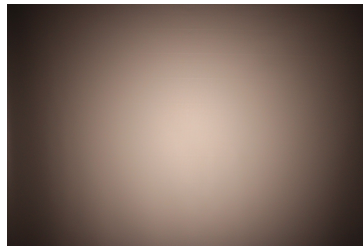

CITIZEN

LED LCN-C09A
 Ordering code C18569_AMY-110-W
 FWHM / FWTM 38.0° / 86.0°
 Efficiency 84 %
 LEDs/each optic 1
 Light colour White
 Required components:

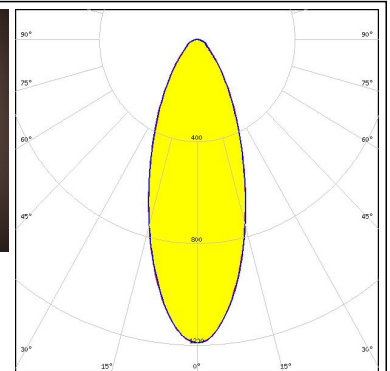
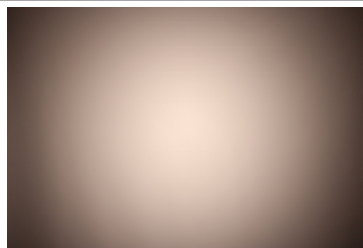

LUMINUS

LED CTM-14 (Tunable White) Gen2
 Ordering code CP18573_AMY-110-W-C
 FWHM / FWTM 35.0° / 63.5°
 Efficiency 88 %
 LEDs/each optic 1
 Light colour White
 Required components:
 C16142_HEKLA-SOCKET-K
 Bender Wirth: 442 Typ L8

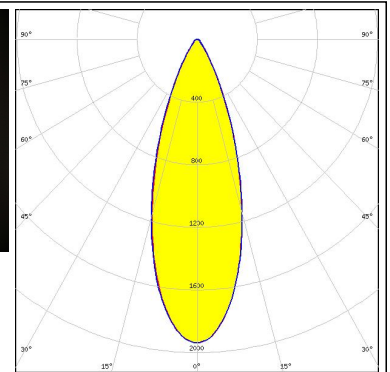
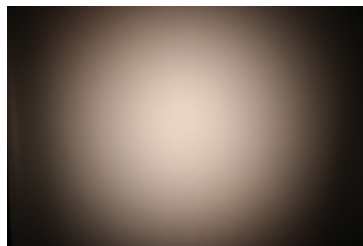

OPTICAL RESULTS (SIMULATED):

bridgelux.

LED V10 Gen 8-9
 Ordering code CP18573_AMY-110-W-C
 FWHM / FWTM 36.0° / 58.0°
 Efficiency 92 %
 Peak intensity 2.3 cd/lm
 LEDs/each optic 1
 Light colour White
 Required components:
 F15255_HEKLA-SOCKET-C

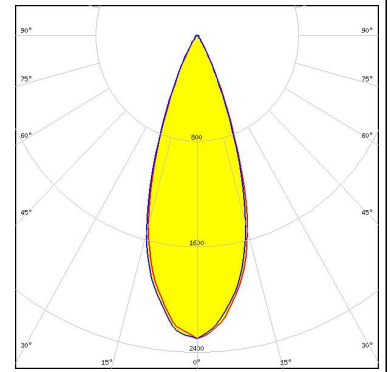

bridgelux.

LED V11 HD Gen 8
 Ordering code CP18573_AMY-110-W-C
 FWHM / FWTM 36.0° / 59.0°
 Efficiency 92 %
 Peak intensity 2.3 cd/lm
 LEDs/each optic 1
 Light colour White
 Required components:
 F15859_HEKLA-SOCKET-I

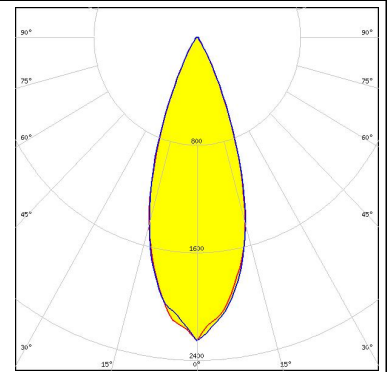

bridgelux.

LED V13 Gen 8-9
 Ordering code CP18573_AMY-110-W-C
 FWHM / FWTM 36.0° / 63.0°
 Efficiency 90 %
 Peak intensity 2 cd/lm
 LEDs/each optic 1
 Light colour White
 Required components:
 F15859_HEKLA-SOCKET-I

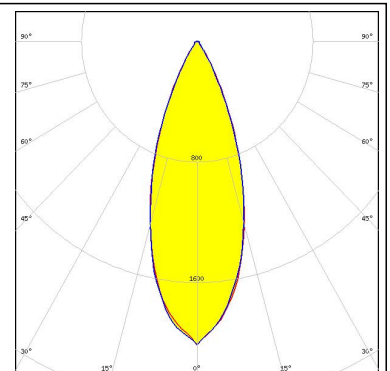

bridgelux.

LED V18 Gen 8-9
 Ordering code CP18573_AMY-110-W-C
 FWHM / FWTM 36.0° / 71.0°
 Efficiency 84 %
 Peak intensity 1.6 cd/lm
 LEDs/each optic 1
 Light colour White
 Required components:
 C16142_HEKLA-SOCKET-K
 Bender Wirth: 462 Typ L8

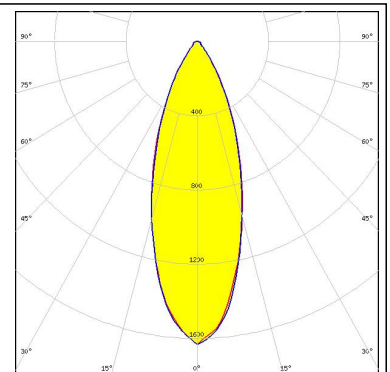

OPTICAL RESULTS (SIMULATED):

		
LED	V8 Gen 8-9	
Ordering code	CP18573_AMY-110-W-C	
FWHM / FWTM	36.0° / 55.0°	
Efficiency	92 %	
Peak intensity	2.5 cd/lm	
LEDs/each optic	1	
Light colour	White	
Required components:		
F15253_HEKLA-SOCKET-A		

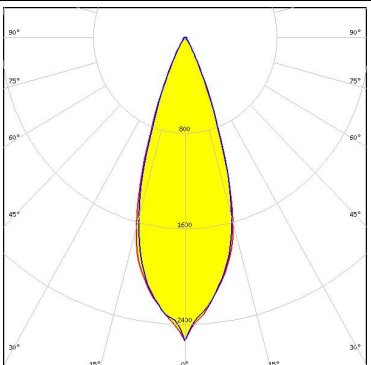
		
LED	V9 HD Gen 8	
Ordering code	CP18573_AMY-110-W-C	
FWHM / FWTM	36.0° / 55.0°	
Efficiency	92 %	
Peak intensity	2.5 cd/lm	
LEDs/each optic	1	
Light colour	White	
Required components:		
F15859_HEKLA-SOCKET-I		

		
LED	Vero SE 10	
Ordering code	CP18573_AMY-110-W-C	
FWHM / FWTM	38.0° / 62.0°	
Efficiency	92 %	
Peak intensity	2 cd/lm	
LEDs/each optic	1	
Light colour	White	
Required components:		
C16142_HEKLA-SOCKET-K		

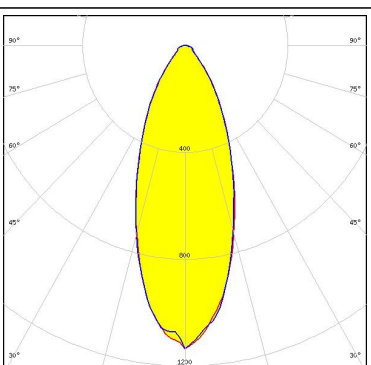
		
LED	Vero SE 29	
Ordering code	CP18573_AMY-110-W-C	
FWHM / FWTM	40.0° / 83.0°	
Efficiency	77 %	
Peak intensity	1.1 cd/lm	
LEDs/each optic	1	
Light colour	White	
Required components:		

OPTICAL RESULTS (SIMULATED):

bridgelux

LED Vero SE 29
 Ordering code CP19030_AMY-110-W-C-WHT
 FWHM / FWTM 40.0° / 86.0°
 Efficiency 85 %
 Peak intensity 1.2 cd/lm
 LEDs/each optic 1
 Light colour White
 Required components:

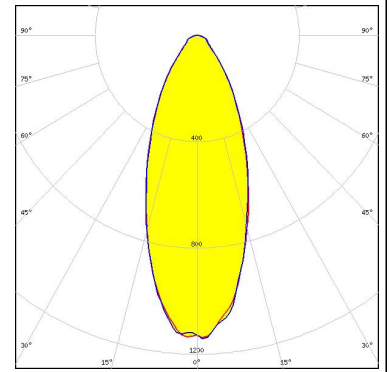

bridgelux

LED VERO18
 Ordering code CP18573_AMY-110-W-C
 FWHM / FWTM 37.0° / 73.0°
 Efficiency 89 %
 Peak intensity 1.7 cd/lm
 LEDs/each optic 1
 Light colour White
 Required components:
 C16142_HEKLA-SOCKET-K

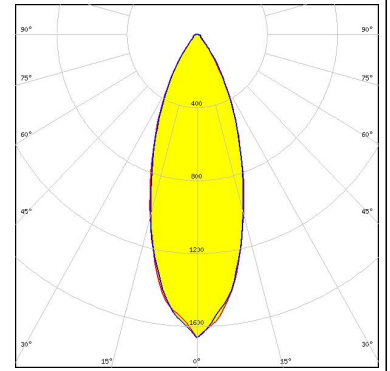

bridgelux

LED Vesta DTW 13mm (21W)
 Ordering code CP18573_AMY-110-W-C
 FWHM / FWTM 36.0° / 54.0°
 Efficiency 93 %
 Peak intensity 2.5 cd/lm
 LEDs/each optic 1
 Light colour White
 Required components:
 Bender Wirth: 632b Hekla XL

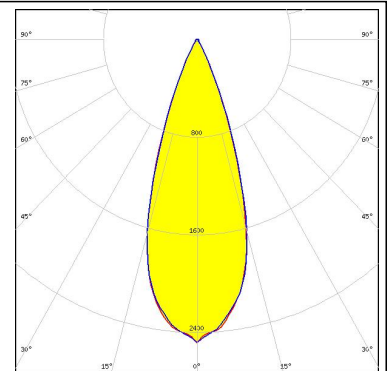

bridgelux

LED Vesta DTW 9mm (4W/6W/12W)
 Ordering code CP18573_AMY-110-W-C
 FWHM / FWTM 36.0° / 55.0°
 Efficiency 93 %
 Peak intensity 2.4 cd/lm
 LEDs/each optic 1
 Light colour White
 Required components:
 Bender Wirth: 652b Hekla

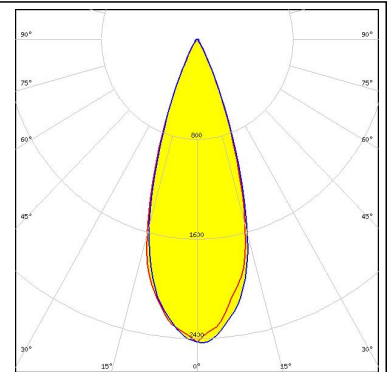

OPTICAL RESULTS (SIMULATED):



LED Vesta SE 13mm TW
Ordering code CP18573_AMY-110-W-C
FWHM / FWTM 34.0° / 60.0°
Efficiency 86 %
Peak intensity 2.1 cd/lm
LEDs/each optic 1
Light colour Tunable White
Required components:
 C16142_HEKLA-SOCKET-K

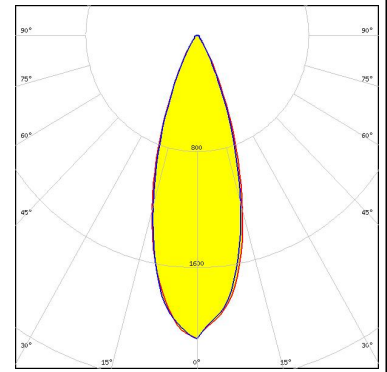

LED Vesta TW 18mm (31W) DP
Ordering code CP18573_AMY-110-W-C
FWHM / FWTM 36.0° / 71.0°
Efficiency 84 %
Peak intensity 1.6 cd/lm
LEDs/each optic 1
Light colour White
Required components:
 C16142_HEKLA-SOCKET-K
 Bender Wirth: 462 Typ L8

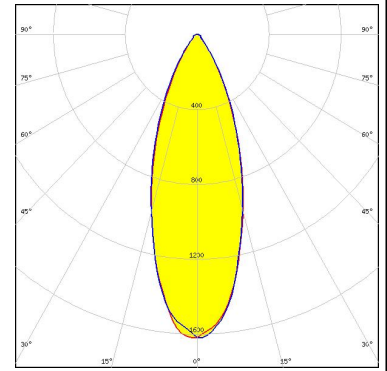

LED Vesta TW 9mm (9W) DP
Ordering code CP18573_AMY-110-W-C
FWHM / FWTM 39.0° / 60.0°
Efficiency 93 %
Peak intensity 2.1 cd/lm
LEDs/each optic 1
Light colour White
Required components:
 C16142_HEKLA-SOCKET-K
 Bender Wirth: 489 Typ L8

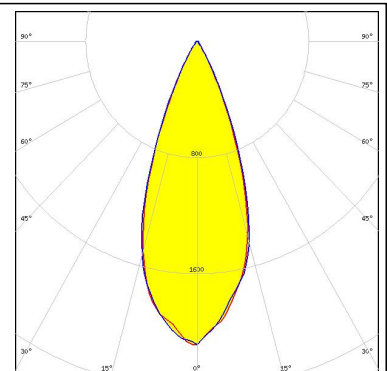

CITIZEN

LED CLL03x/CLU03x
Ordering code CP19030_AMY-110-W-C-WHT
FWHM / FWTM 37.0° / 64.0°
Efficiency 95 %
Peak intensity 2.1 cd/lm
LEDs/each optic 1
Light colour White
Required components:
 F17438_HEKLA-G2-I

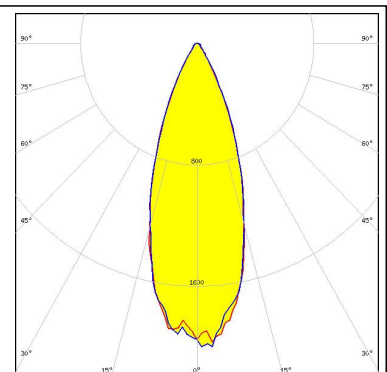

OPTICAL RESULTS (SIMULATED):

CITIZEN

LED CLL03x/CLU03x
Ordering code CP18577_AMY-110-W-B
FWHM / FWTM 35.0° / 62.0°
Efficiency 91 %
Peak intensity 2.3 cd/lm
LEDs/each optic 1
Light colour White
Required components:
BJB: 47.319.2021

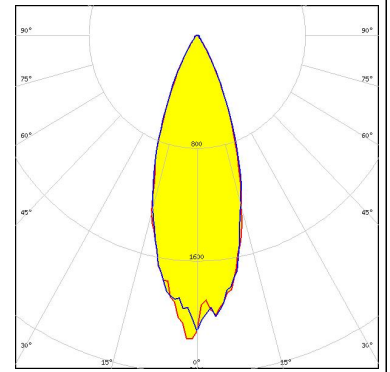

CITIZEN

LED CLL03x/CLU03x
Ordering code C18569_AMY-110-W
FWHM / FWTM 35.0° / 62.0°
Efficiency 90 %
Peak intensity 2.1 cd/lm
LEDs/each optic 1
Light colour White
Required components:
F17438_HEKLA-G2-I

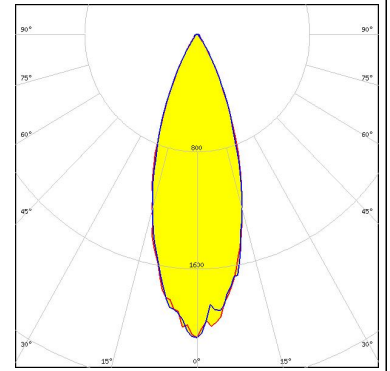

CITIZEN

LED CLL03x/CLU03x
Ordering code CP19034_AMY-110-W-B-WHT
FWHM / FWTM 35.0° / 62.0°
Efficiency 95 %
Peak intensity 2.2 cd/lm
LEDs/each optic 1
Light colour White
Required components:
BJB: 47.319.2021

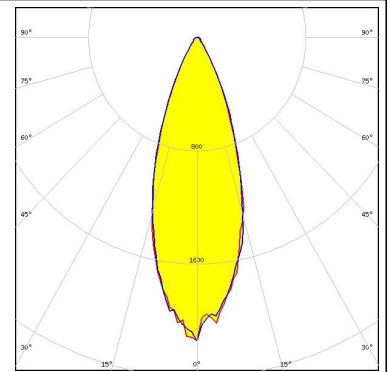

CITIZEN

LED CLL03x/CLU03x
Ordering code CP18573_AMY-110-W-C
FWHM / FWTM 35.0° / 62.0°
Efficiency 90 %
Peak intensity 2.1 cd/lm
LEDs/each optic 1
Light colour White
Required components:
F17438_HEKLA-G2-I

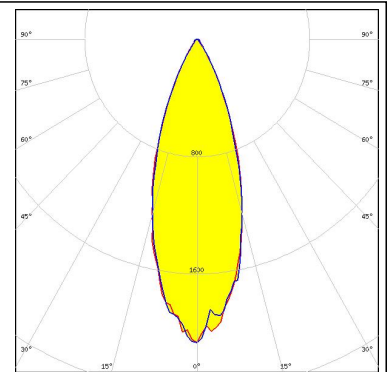

OPTICAL RESULTS (SIMULATED):

CITIZEN

LED CLL04x/CLU04x
Ordering code C18569_AMY-110-W
FWHM / FWTM 34.0° / 71.0°
Efficiency 87 %
Peak intensity 1.8 cd/lm
LEDs/each optic 1
Light colour White
Required components:
BJB: 47.319.2030

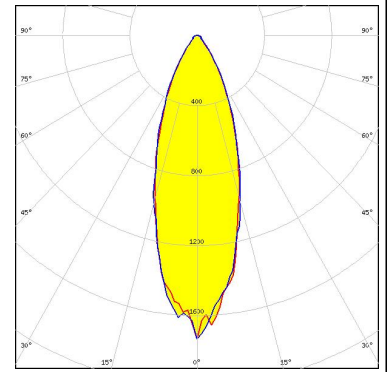

CITIZEN

LED CLL04x/CLU04x
Ordering code CP19034_AMY-110-W-B-WHT
FWHM / FWTM 34.0° / 72.0°
Efficiency 94 %
Peak intensity 1.8 cd/lm
LEDs/each optic 1
Light colour White
Required components:
BJB: 47.319.2030

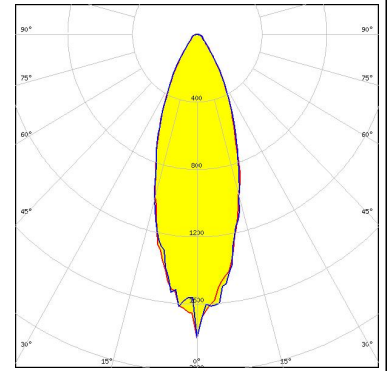

CITIZEN

LED CLL04x/CLU04x
Ordering code CP18577_AMY-110-W-B
FWHM / FWTM 34.0° / 71.0°
Efficiency 87 %
Peak intensity 1.8 cd/lm
LEDs/each optic 1
Light colour White
Required components:
BJB: 47.319.2030

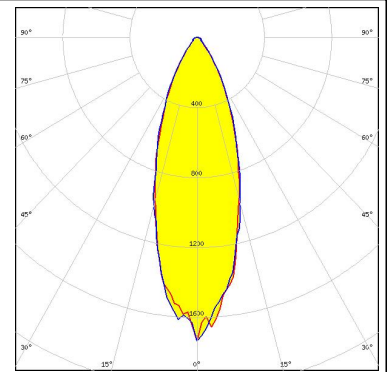

LUMILEDS

LED LUXEON CX Plus CoB L08 (Gen2)
Ordering code CP18573_AMY-110-W-C
FWHM / FWTM 36.0° / 62.0°
Efficiency 91 %
Peak intensity 2.1 cd/lm
LEDs/each optic 1
Light colour White
Required components:
Bender Wirth: 637a Hekla

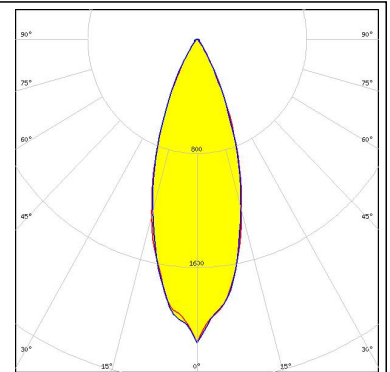

OPTICAL RESULTS (SIMULATED):

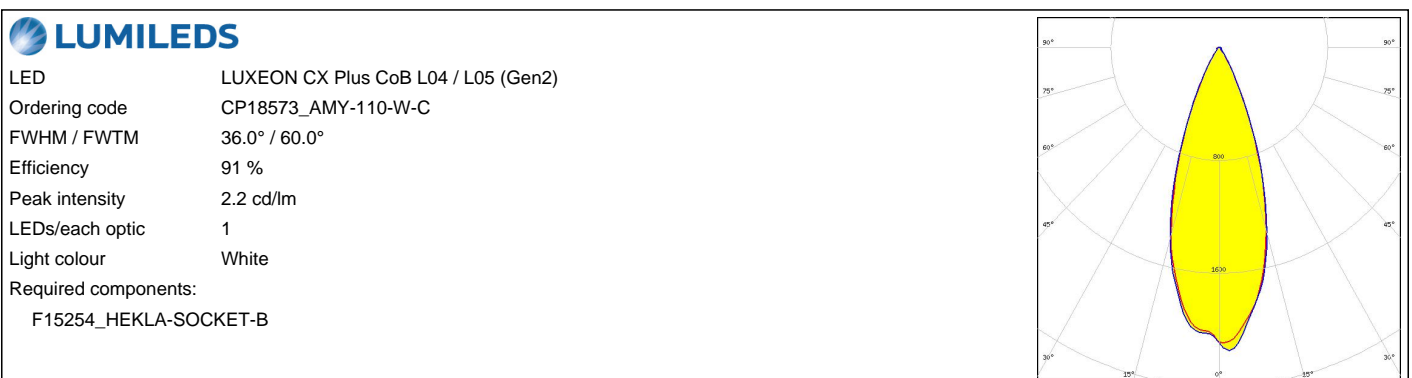
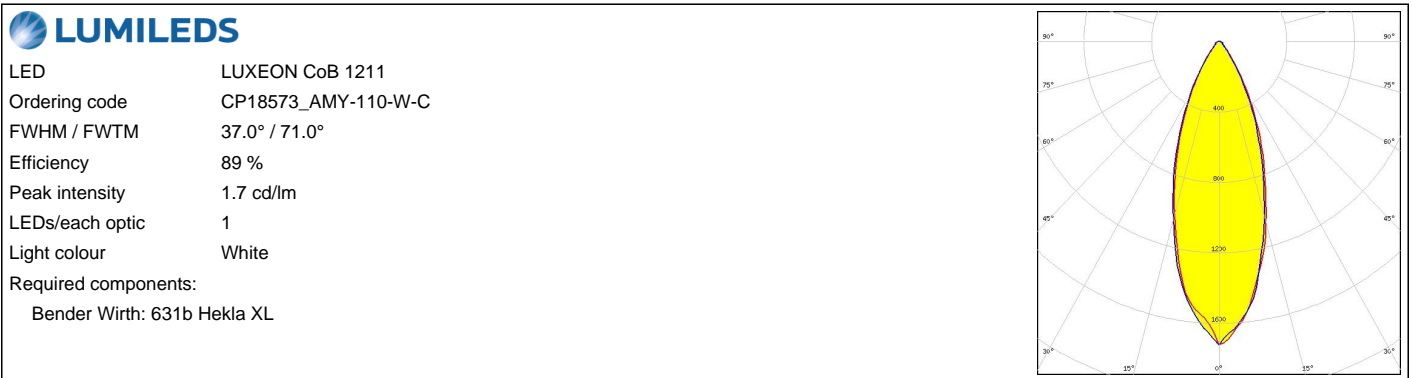

OPTICAL RESULTS (SIMULATED):



LED COB J-Type
Ordering code CP18573_AMY-110-W-C
FWHM / FWTM 38.0° / 64.0°
Efficiency 91 %
Peak intensity 2 cd/lm
LEDs/each optic 1
Light colour White
Required components:
Bender Wirth: 663a Hekla XL

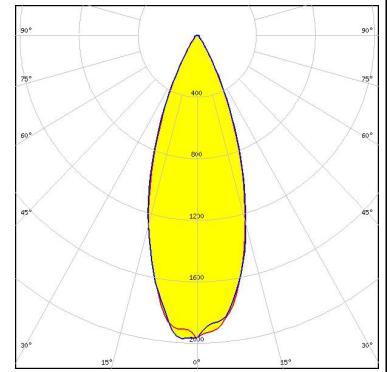

SAMSUNG

LED LC016D / LC019D / LC026D / LC033D
Ordering code CP19034_AMY-110-W-B-WHT
FWHM / FWTM 36.0° / 66.0°
Efficiency 95 %
Peak intensity 2.1 cd/lm
LEDs/each optic 1
Light colour White
Required components:
BJB: 47.319.2021

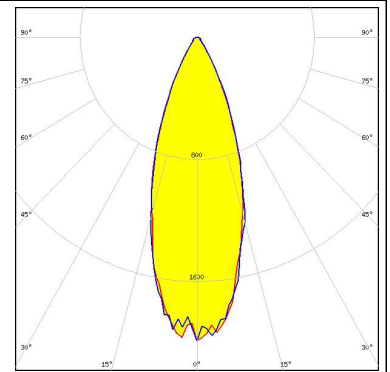

SAMSUNG

LED LC016D / LC019D / LC026D / LC033D
Ordering code CP18573_AMY-110-W-C
FWHM / FWTM 35.0° / 65.0°
Efficiency 89 %
Peak intensity 2.1 cd/lm
LEDs/each optic 1
Light colour White
Required components:
F17438_HEKLA-G2-I

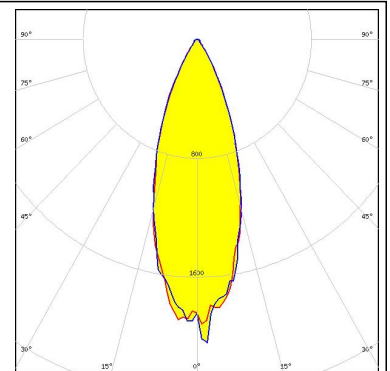

SAMSUNG

LED LC016D / LC019D / LC026D / LC033D
Ordering code CP19030_AMY-110-W-C-WHT
FWHM / FWTM 34.0° / 65.0°
Efficiency 95 %
Peak intensity 2.2 cd/lm
LEDs/each optic 1
Light colour White
Required components:
F17438_HEKLA-G2-I

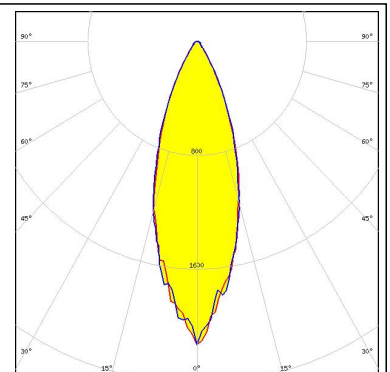

OPTICAL RESULTS (SIMULATED):

SAMSUNG

LED LC016D / LC019D / LC026D / LC033D
 Ordering code CP18577_AMY-110-W-B
 FWHM / FWTM 34.0° / 64.0°
 Efficiency 90 %
 Peak intensity 2.1 cd/lm
 LEDs/each optic 1
 Light colour White
 Required components:
 BJB: 47.319.2021

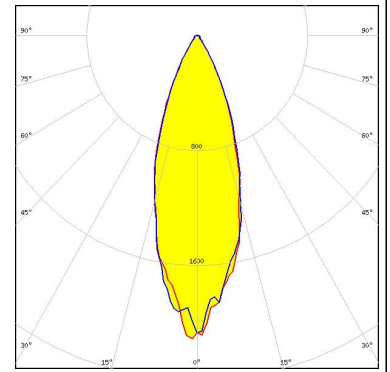

SAMSUNG

LED LC016D / LC019D / LC026D / LC033D
 Ordering code C18569_AMY-110-W
 FWHM / FWTM 35.0° / 65.0°
 Efficiency 89 %
 Peak intensity 2.1 cd/lm
 LEDs/each optic 1
 Light colour White
 Required components:
 F17438_HEKLA-G2-I

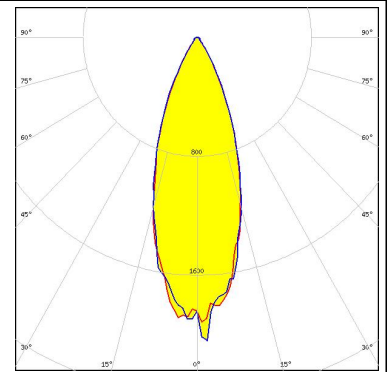

SAMSUNG

LED LC020T (Tunable white)
 Ordering code CP18573_AMY-110-W-C
 FWHM / FWTM 37.0° / 58.0°
 Efficiency 92 %
 Peak intensity 2.2 cd/lm
 LEDs/each optic 1
 Light colour Tunable White
 Required components:
 C16142_HEKLA-SOCKET-K
 Bender Wirth: 501 Typ L8

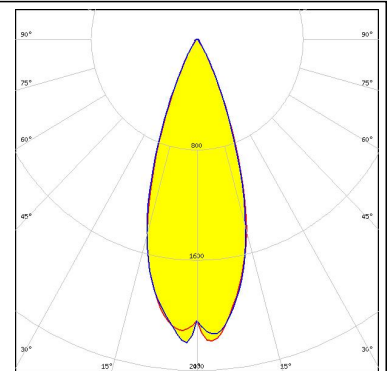

SAMSUNG

LED LC040D / LC060D / LC080D
 Ordering code CP18573_AMY-110-W-C
 FWHM / FWTM 38.0° / 79.0°
 Efficiency 80 %
 Peak intensity 1.4 cd/lm
 LEDs/each optic 1
 Light colour White
 Required components:
 Bender Wirth: 631b Hekla XL

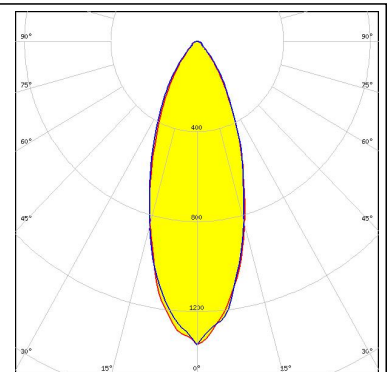

OPTICAL RESULTS (SIMULATED):

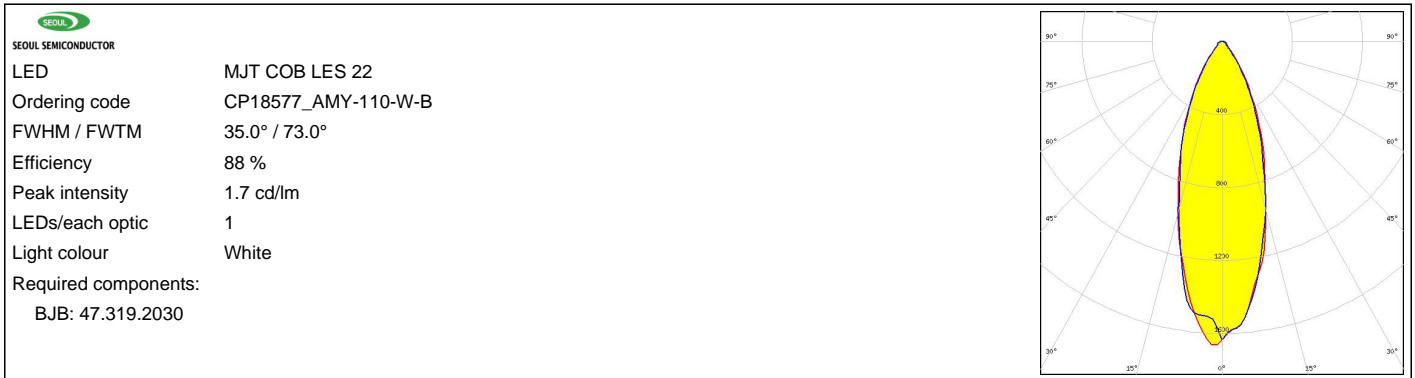

GENERAL INFORMATION:

NOTE: The typical beam angle will be changed by different color, chip size and chip position tolerance. The typical total beam angle is the full angle measured where the luminous intensity is half of the peak value.

Due to use of high power COB's with this product, special attention to proper thermal design is highly recommended. LEDiL has no liability for direct, indirect or consecutive damages arising from the LEDiL products being used outside of the recommended temperature range.

MATERIALS:

As part of our continuous research and improvement processes, and to ensure the best possible quality and availability of our products, LEDiL reserves the right to change material grades without notice.

PRODUCT DATA USER AGREEMENT AND DISCLAIMER:

The measured data in the provided downloadable LEDiL Product Datasheets and Mechanical 2D-Drawings is rounded and provided as reference for planning. LEDiL Oy's optical specifications have been verified by conducting performance testing of the products in accordance with the company's quality system. The reported data are averaged results of multiple measurements with typical variation. LEDiL Oy reserves the right to without prior notification make changes and improvements to its products.

LEDiL Oy assumes neither warranty, nor guarantee nor any other liability of any kind for the contents and correctness of the provided data. The provided data has been generated with highest diligence but the provided data may in reality not represent the complete possible variation range of all intrinsic parameters. Therefore, in certain cases a deviation from the provided data could occur.

LEDiL Oy reserves the right to undertake technical changes of its products without further notification which could lead to changes in the provided data. LEDiL Oy assumes no liability of any kind for the possible deviation from any provided data or any other damage resulting from the usage of the provided data.

The user agrees to this disclaimer and user agreement with the download or usage of the provided files.

LEDiL Oy

Joensuunkatu 13
FI-24240 SALO
Finland

LEDiL Inc.

228 West Page Street
Suite D
Sycamore IL 60178
USA

Ledil Optics Technology (Shenzhen) Co., Ltd.

405 , Block B
Casic Motor Building
Shenzhen 518057
P.R.CHINA

Local sales and technical support

[www.ledil.com/
where_to_buy](http://www.ledil.com/where_to_buy)

Shipping locations

Salo, Finland
Hong Kong, China

Distribution Partners

[www.ledil.com/
where_to_buy](http://www.ledil.com/where_to_buy)