

## AMY-110-M

~24° medium beam

### SPECIFICATION:

Dimensions	Ø 109.7 mm
Height	17.1 mm
Fastening	socket
ROHS compliant	yes ⓘ

### MATERIALS:

Component	Type	Material	Colour	Finish	Length (mm)
AMY-110-M	Single lens	PMMA	clear		
AMY-110-HLD-C	Holder C	PC	black		
AMY-110-HLD-B	Holder B	PC	black		
AMY-110-HLD-C-WHT	Holder C	PC	white		
AMY-110-HLD-B-WHT	Holder B	PC	white		



### ORDERING INFORMATION:

Component	Qty in box	MOQ	MPQ	Box weight (kg)
C18568_AMY-110-M	128	128	8	10.8
<b>Assembly</b>				
CP19033_AMY-110-M-B-WHT	77	77	7	8.5
CP19029_AMY-110-M-C-WHT	77	77	7	8.5
CP18576_AMY-110-M-B	77	77	7	8.5
CP18572_AMY-110-M-C	77	77	7	8.6

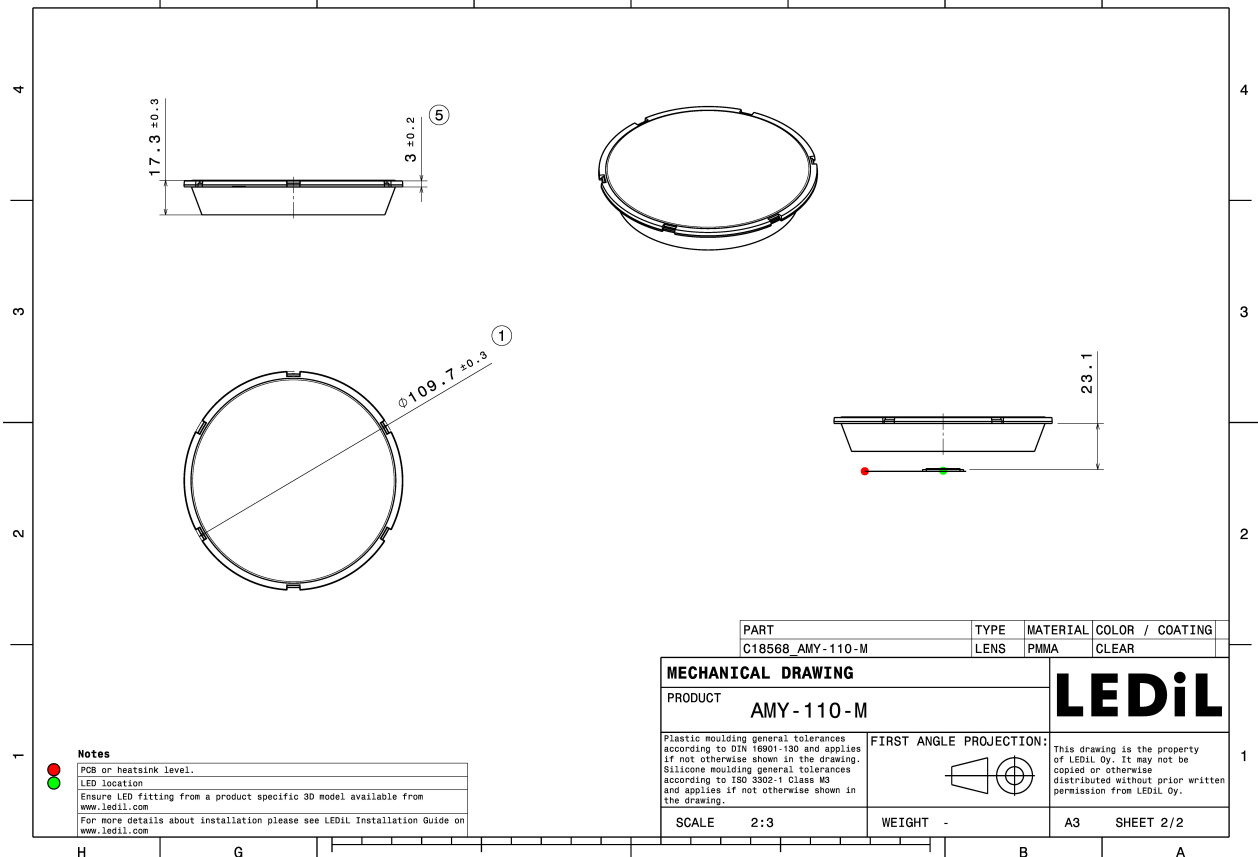
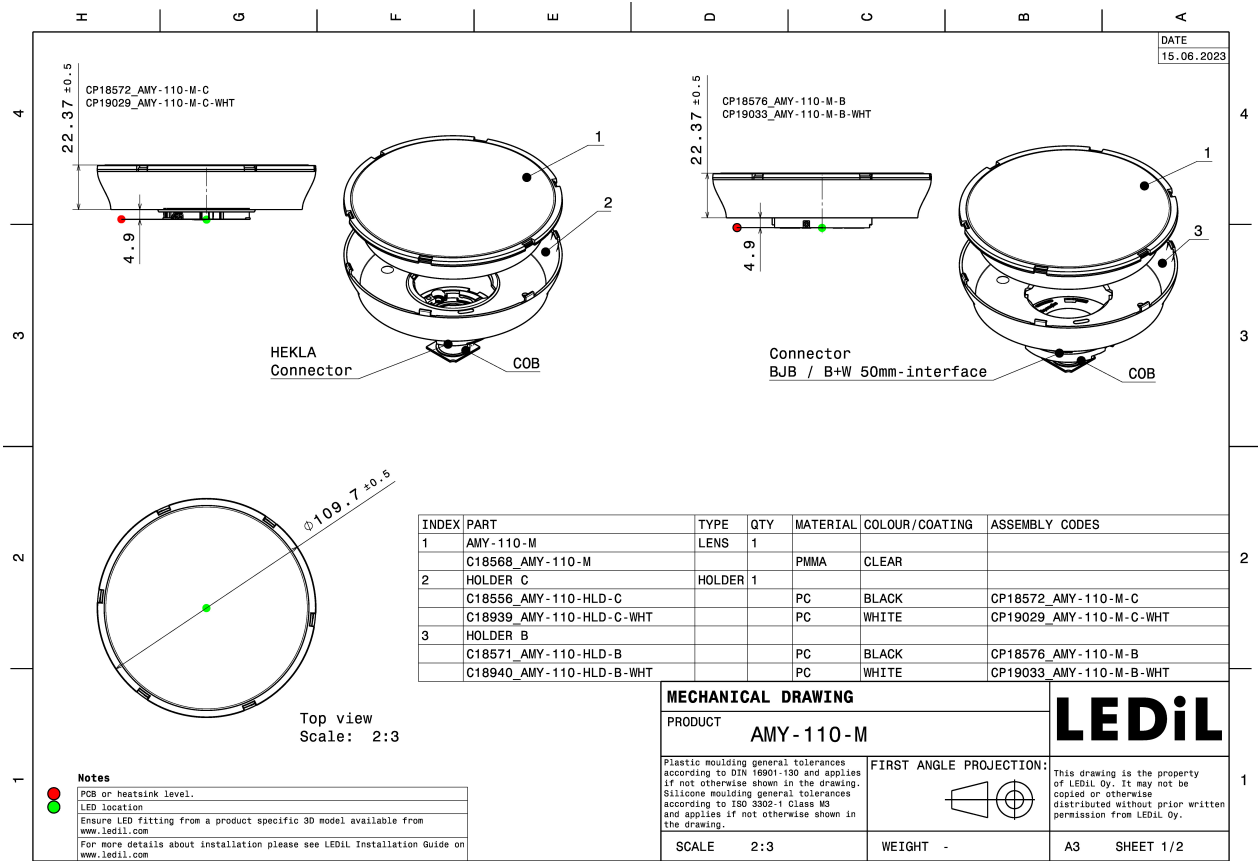

See also our general installation guide: [www.ledil.com/installation\\_guide](http://www.ledil.com/installation_guide)

### OPTICAL RESULTS (MEASURED):

#### CITIZEN

LED LCN-C07A  
Ordering code C18568\_AMY-110-M  
FWHM / FWTM 28.0° / 61.0°  
Efficiency 88 %  
LEDs/each optic 1  
Light colour/type White  
Required components:

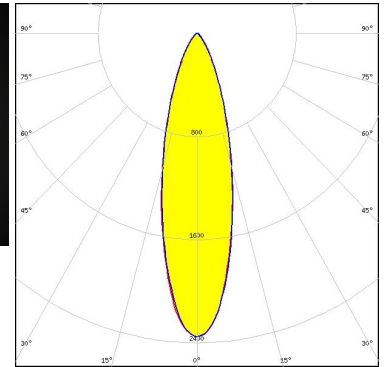

Light distribution files

#### CITIZEN

LED LCN-C08A  
Ordering code C18568\_AMY-110-M  
FWHM / FWTM 33.0° / 72.0°  
Efficiency 87 %  
LEDs/each optic 1  
Light colour/type White  
Required components:

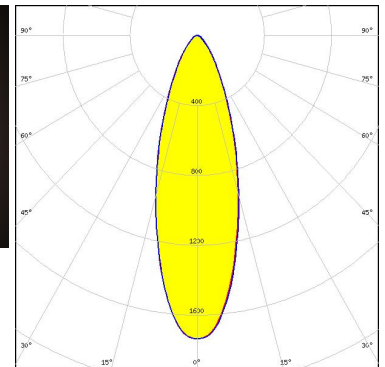
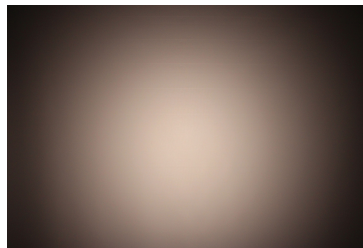

Light distribution files

#### CITIZEN

LED LCN-C09A  
Ordering code C18568\_AMY-110-M  
FWHM / FWTM 34.0° / 75.0°  
Efficiency 86 %  
LEDs/each optic 1  
Light colour/type White  
Required components:

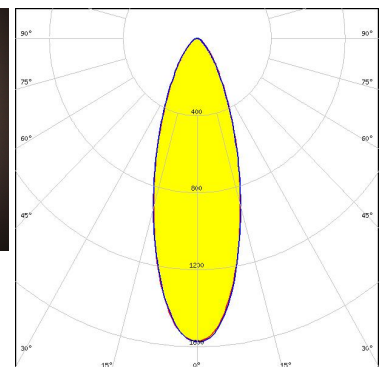
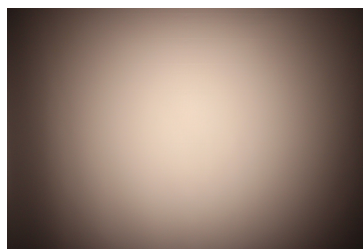

Light distribution files



### OPTICAL RESULTS (MEASURED):



LED CTM-14 (Tunable White) Gen2  
Ordering code CP18572\_AMY-110-M-C  
FWHM / FWTM 24.0° / 49.0°  
Efficiency 89 %  
LEDs/each optic 1  
Light colour/type White  
Required components:  
C16142\_HEKLA-SOCKET-K  
Bender Wirth: 442 Typ L8

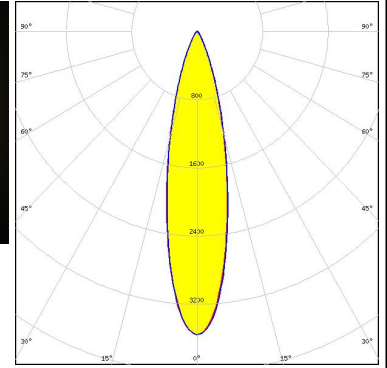

Light distribution files

### OPTICAL RESULTS (SIMULATED):



LED V10 Gen 8-9  
Ordering code CP18572\_AMY-110-M-C  
FWHM / FWTM 24.0° / 44.0°  
Efficiency 93 %  
Peak intensity 4.4 cd/lm  
LEDs/each optic 1  
Light colour/type White  
Required components:  
F15255\_HEKLA-SOCKET-C

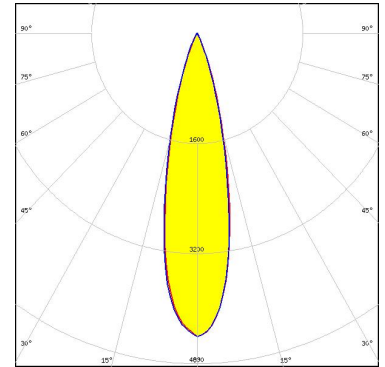

Light distribution files



LED V11 HD Gen 8  
Ordering code CP18572\_AMY-110-M-C  
FWHM / FWTM 24.0° / 46.0°  
Efficiency 93 %  
Peak intensity 4.2 cd/lm  
LEDs/each optic 1  
Light colour/type White  
Required components:  
F15859\_HEKLA-SOCKET-I

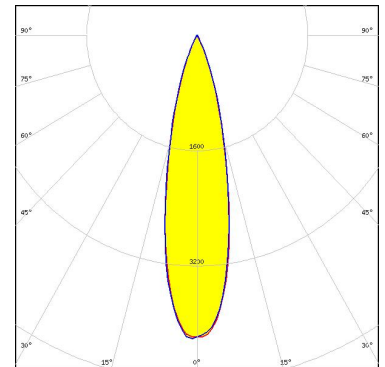

Light distribution files



LED V13 Gen 8-9  
Ordering code CP18572\_AMY-110-M-C  
FWHM / FWTM 26.0° / 52.0°  
Efficiency 92 %  
Peak intensity 3.6 cd/lm  
LEDs/each optic 1  
Light colour/type White  
Required components:  
F15859\_HEKLA-SOCKET-I

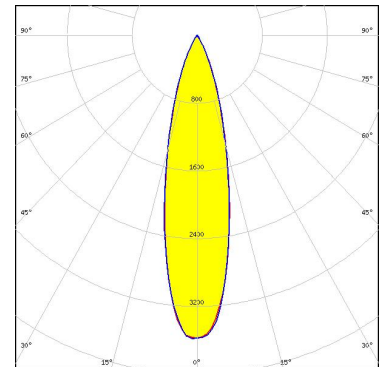

Light distribution files

### OPTICAL RESULTS (SIMULATED):

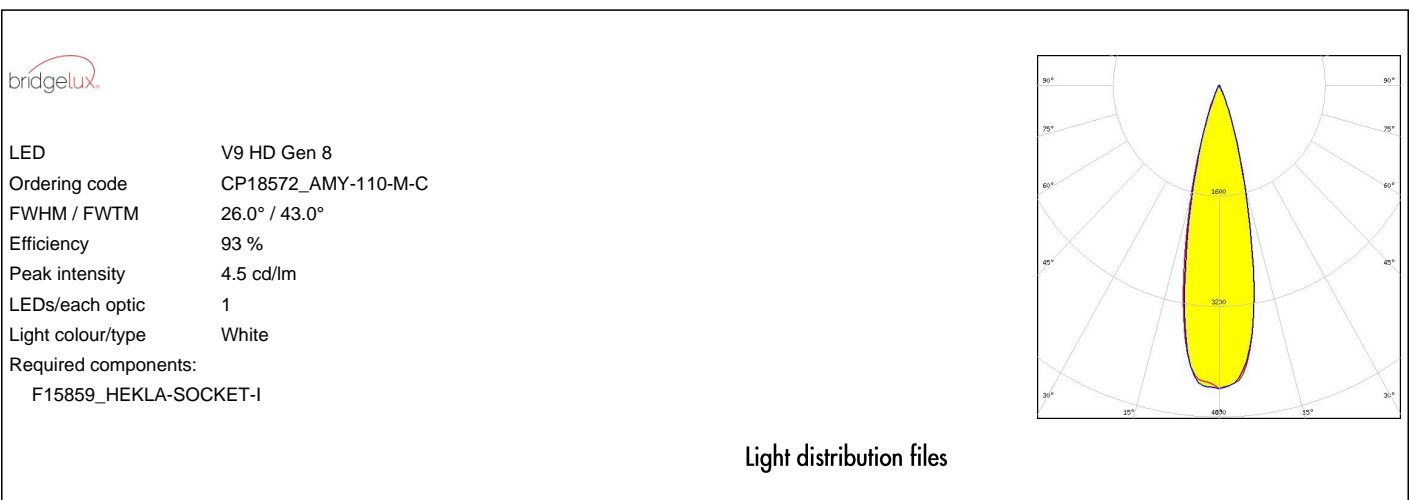
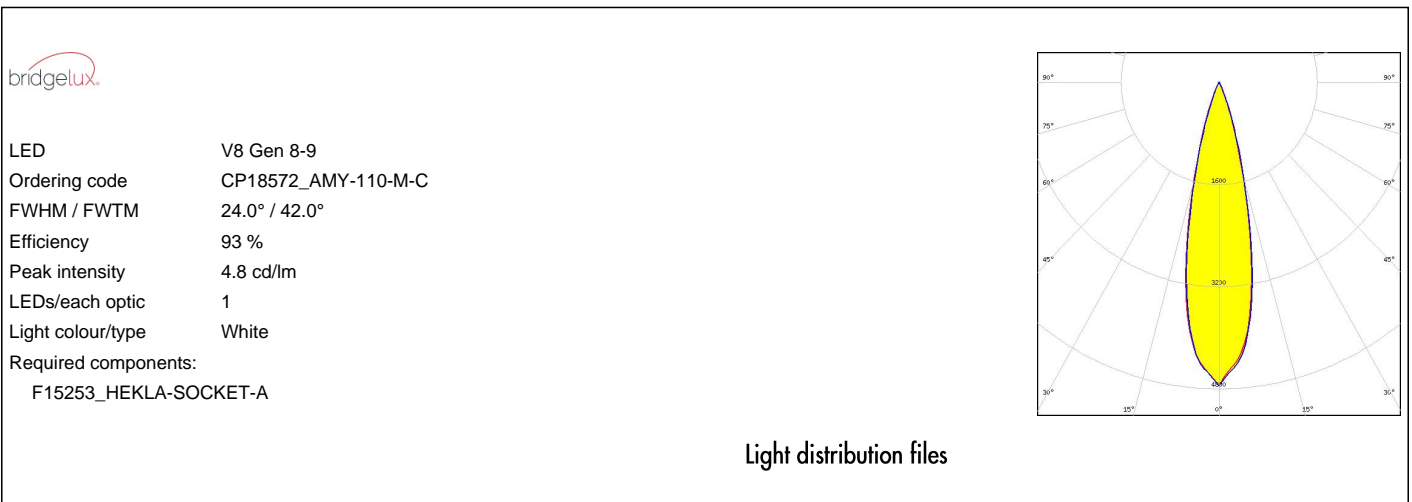
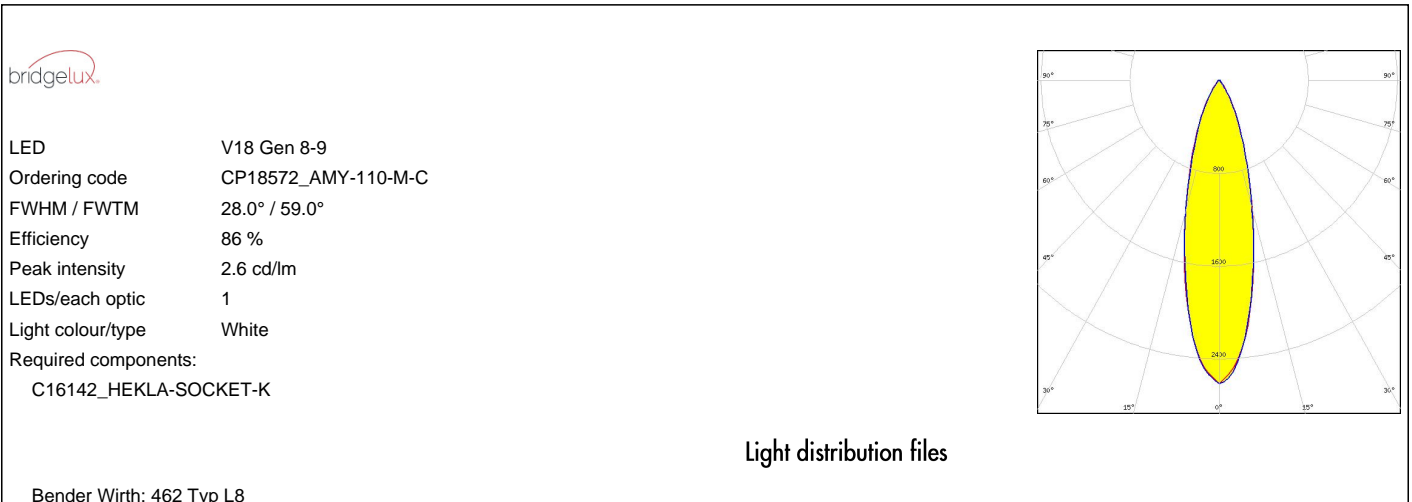

### OPTICAL RESULTS (SIMULATED):



**LED** Vero SE 29  
**Ordering code** CP19029\_AMY-110-M-C-WHT  
**FWHM / FWTM** 36.0° / 78.0°  
**Efficiency** 88 %  
**Peak intensity** 1.5 cd/lm  
**LEDs/each optic** 1  
**Light colour/type** White  
**Required components:**

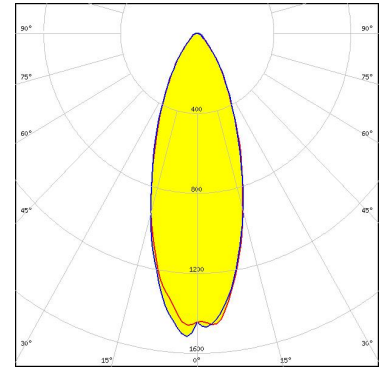

Light distribution files



**LED** Vero SE 29  
**Ordering code** CP18572\_AMY-110-M-C  
**FWHM / FWTM** 36.0° / 75.0°  
**Efficiency** 81 %  
**Peak intensity** 1.5 cd/lm  
**LEDs/each optic** 1  
**Light colour/type** White  
**Required components:**

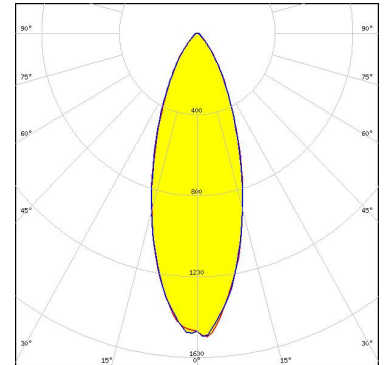

Light distribution files



**LED** VERO13  
**Ordering code** CP18572\_AMY-110-M-C  
**FWHM / FWTM** 26.0° / 50.0°  
**Efficiency** 93 %  
**Peak intensity** 3.7 cd/lm  
**LEDs/each optic** 1  
**Light colour/type** White  
**Required components:**  
 C16142\_HEKLA-SOCKET-K

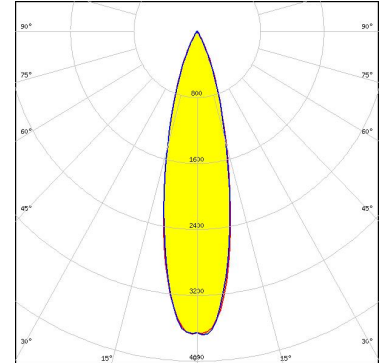

Light distribution files

### OPTICAL RESULTS (SIMULATED):



**LED** VERO18  
**Ordering code** CP18572\_AMY-110-M-C  
**FWHM / FWTM** 28.0° / 60.0°  
**Efficiency** 92 %  
**Peak intensity** 2.7 cd/lm  
**LEDs/each optic** 1  
**Light colour/type** White  
**Required components:**  
 C16142\_HEKLA-SOCKET-K

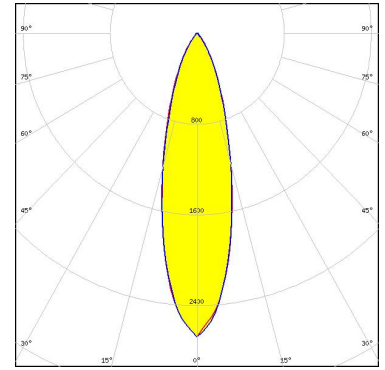

Light distribution files



**LED** Vesta DTW 13mm (21W)  
**Ordering code** CP18572\_AMY-110-M-C  
**FWHM / FWTM** 24.0° / 40.0°  
**Efficiency** 94 %  
**Peak intensity** 4.7 cd/lm  
**LEDs/each optic** 1  
**Light colour/type** White  
**Required components:**

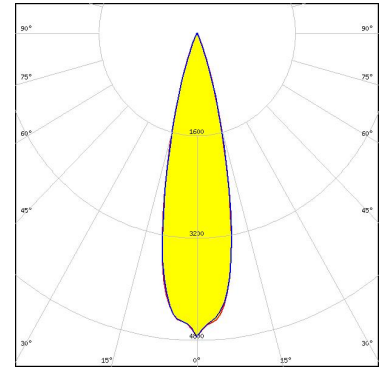

Bender Wirth: 632b Hekla XL

Light distribution files



**LED** Vesta DTW 9mm (4W/6W/12W)  
**Ordering code** CP18572\_AMY-110-M-C  
**FWHM / FWTM** 24.0° / 42.0°  
**Efficiency** 94 %  
**Peak intensity** 4.7 cd/lm  
**LEDs/each optic** 1  
**Light colour/type** White  
**Required components:**

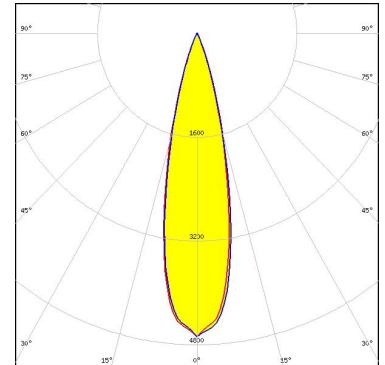

Bender Wirth: 652b Hekla

Light distribution files

### OPTICAL RESULTS (SIMULATED):

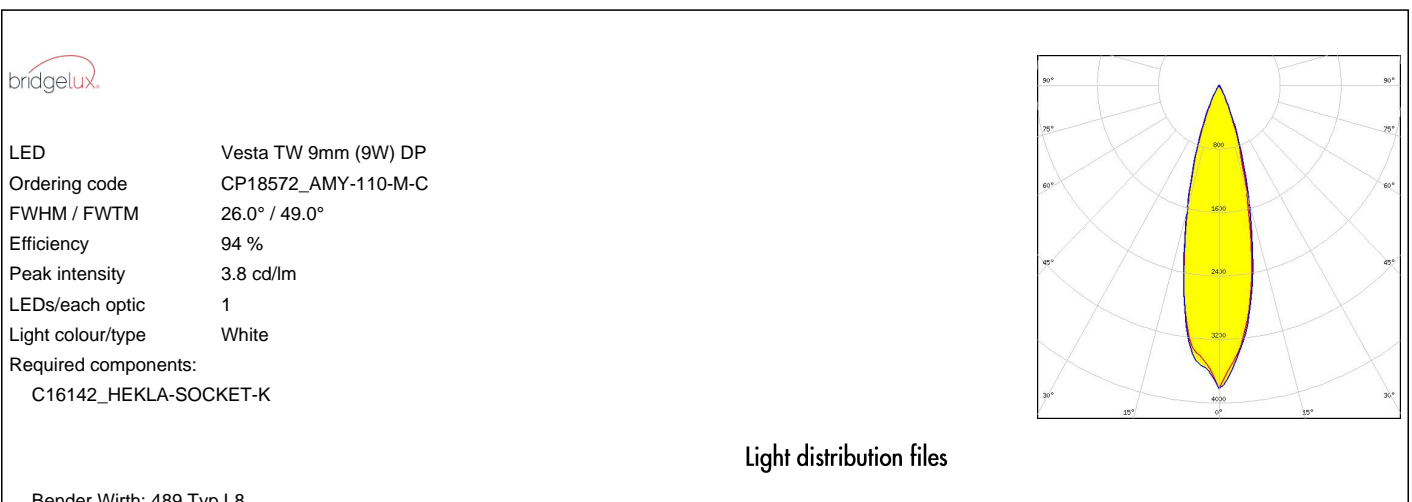
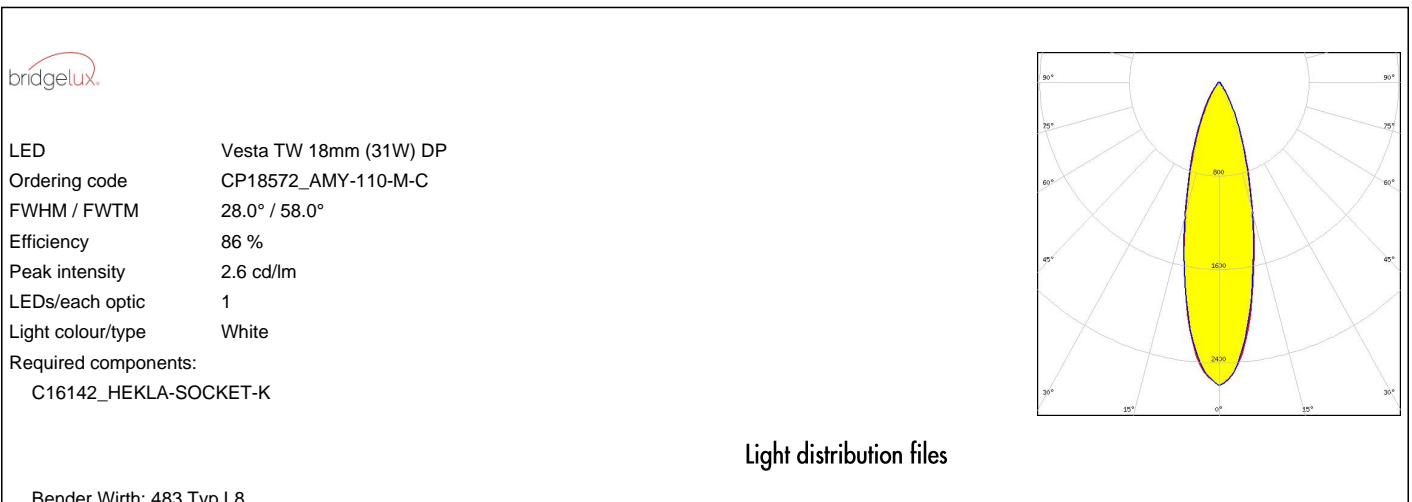
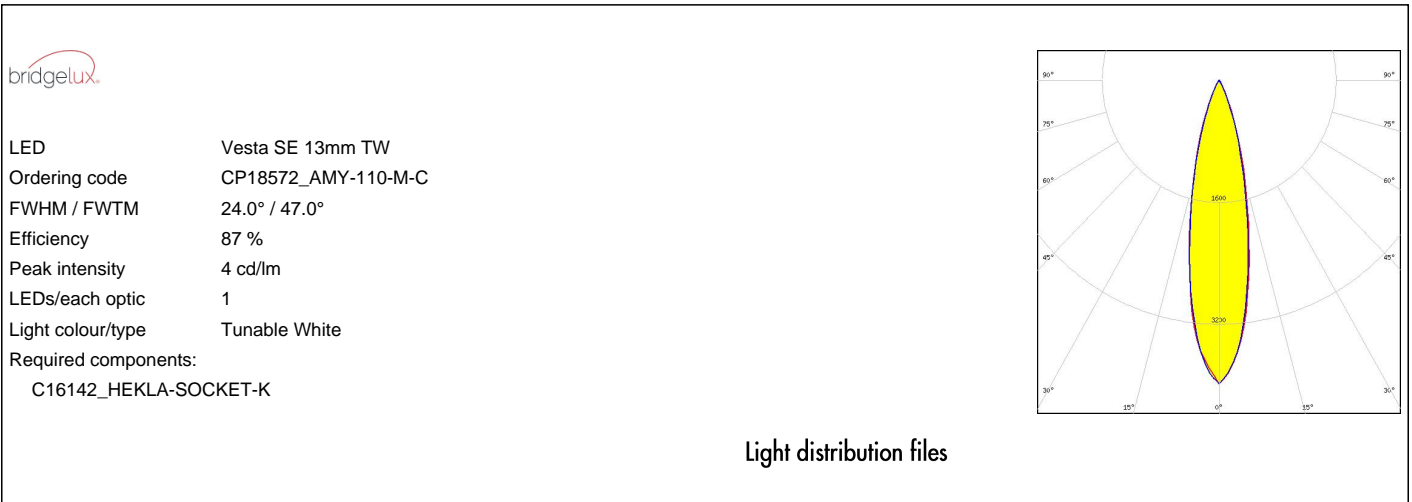

### OPTICAL RESULTS (SIMULATED):

#### CITIZEN

LED CLL03x/CLU03x  
Ordering code C18568\_AMY-110-M  
FWHM / FWTM 24.0° / 50.0°  
Efficiency 91 %  
Peak intensity 3.7 cd/lm  
LEDs/each optic 1  
Light colour/type White  
Required components:  
F17438\_HEKLA-G2-I

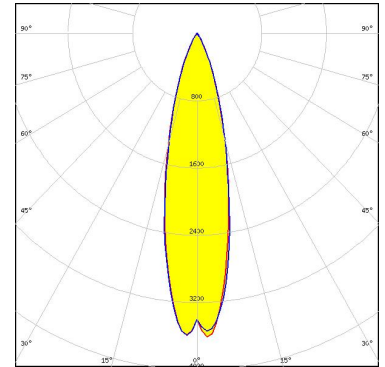

Light distribution files

#### CITIZEN

LED CLL03x/CLU03x  
Ordering code CP19033\_AMY-110-M-B-WHT  
FWHM / FWTM 24.0° / 50.0°  
Efficiency 96 %  
Peak intensity 4 cd/lm  
LEDs/each optic 1  
Light colour/type White  
Required components:

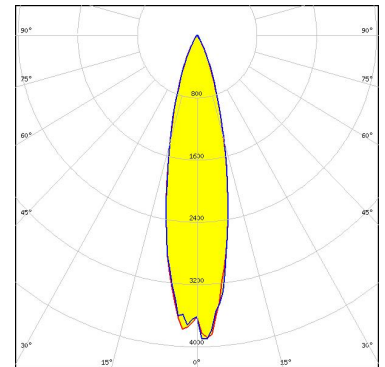

Light distribution files

BJB: 47.319.2021

#### CITIZEN

LED CLL03x/CLU03x  
Ordering code CP18576\_AMY-110-M-B  
FWHM / FWTM 24.0° / 49.0°  
Efficiency 92 %  
Peak intensity 3.9 cd/lm  
LEDs/each optic 1  
Light colour/type White  
Required components:

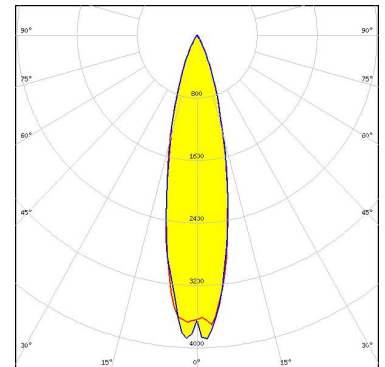

Light distribution files

BJB: 47.319.2021

### OPTICAL RESULTS (SIMULATED):

#### CITIZEN

LED CLL03x/CLU03x  
Ordering code CP19029\_AMY-110-M-C-WHT  
FWHM / FWTM 25.0° / 50.0°  
Efficiency 96 %  
Peak intensity 3.9 cd/lm  
LEDs/each optic 1  
Light colour/type White  
Required components:  
F17438\_HEKLA-G2-I

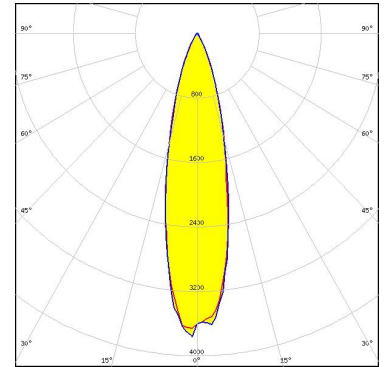

Light distribution files

#### CITIZEN

LED CLL03x/CLU03x  
Ordering code CP18572\_AMY-110-M-C  
FWHM / FWTM 24.0° / 50.0°  
Efficiency 91 %  
Peak intensity 3.7 cd/lm  
LEDs/each optic 1  
Light colour/type White  
Required components:  
F17438\_HEKLA-G2-I

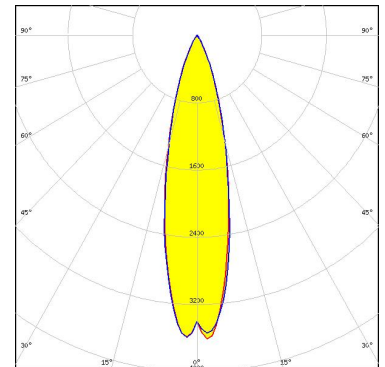

Light distribution files

#### CITIZEN

LED CLL04x/CLU04x  
Ordering code C18568\_AMY-110-M  
FWHM / FWTM 28.0° / 60.0°  
Efficiency 90 %  
Peak intensity 2.7 cd/lm  
LEDs/each optic 1  
Light colour/type White  
Required components:

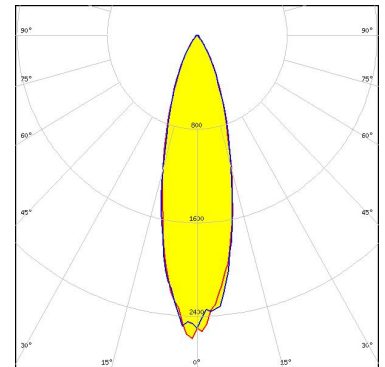

Light distribution files

BJB: 47.319.2030



### OPTICAL RESULTS (SIMULATED):

#### CITIZEN

LED CLL04x/CLU04x  
Ordering code CP19033\_AMY-110-M-B-WHT  
FWHM / FWTM 29.0° / 62.0°  
Efficiency 95 %  
Peak intensity 2.7 cd/lm  
LEDs/each optic 1  
Light colour/type White  
Required components:

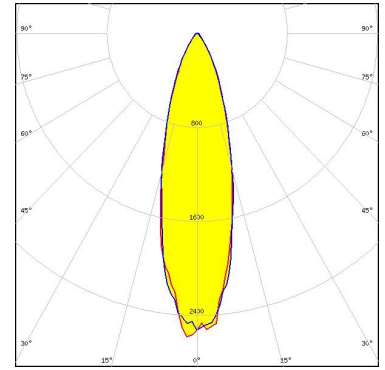

BJB: 47.319.2030

Light distribution files

#### CITIZEN

LED CLL04x/CLU04x  
Ordering code CP18576\_AMY-110-M-B  
FWHM / FWTM 28.0° / 60.0°  
Efficiency 90 %  
Peak intensity 2.7 cd/lm  
LEDs/each optic 1  
Light colour/type White  
Required components:

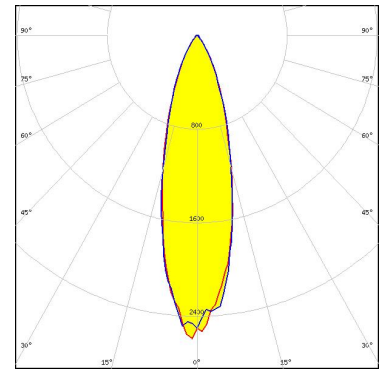

BJB: 47.319.2030

Light distribution files



LED LUXEON CX Plus CoB L08 (Gen2)  
Ordering code CP18572\_AMY-110-M-C  
FWHM / FWTM 24.0° / 50.0°  
Efficiency 93 %  
Peak intensity 3.9 cd/lm  
LEDs/each optic 1  
Light colour/type White  
Required components:

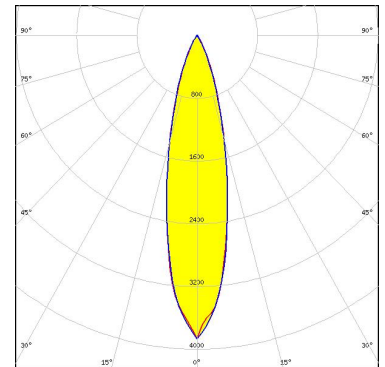

Bender Wirth: 637a Hekla

Light distribution files

### OPTICAL RESULTS (SIMULATED):



**LED** LUXEON CoB 1205HD  
**Ordering code** CP18572\_AMY-110-M-C  
**FWHM / FWTM** 24.0° / 46.0°  
**Efficiency** 93 %  
**Peak intensity** 4.2 cd/lm  
**LEDs/each optic** 1  
**Light colour/type** White  
**Required components:**  
 F15858\_HEKLA-SOCKET-H

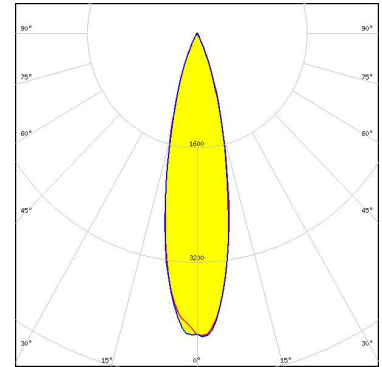

Light distribution files



**LED** LUXEON CoB 1208  
**Ordering code** CP18572\_AMY-110-M-C  
**FWHM / FWTM** 26.0° / 50.0°  
**Efficiency** 93 %  
**Peak intensity** 3.7 cd/lm  
**LEDs/each optic** 1  
**Light colour/type** White  
**Required components:**

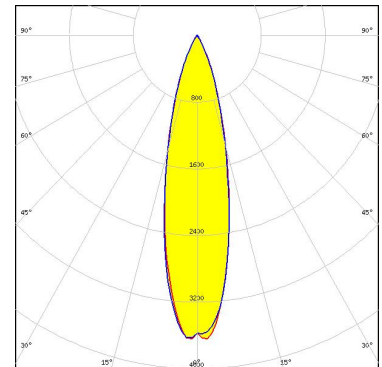

Bender Wirth: 632a Hekla XL

Light distribution files



**LED** LUXEON CoB 1211  
**Ordering code** CP18572\_AMY-110-M-C  
**FWHM / FWTM** 28.0° / 59.0°  
**Efficiency** 91 %  
**Peak intensity** 2.7 cd/lm  
**LEDs/each optic** 1  
**Light colour/type** White  
**Required components:**

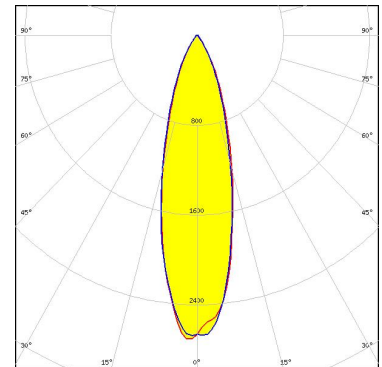

Bender Wirth: 631b Hekla XL

Light distribution files

### OPTICAL RESULTS (SIMULATED):

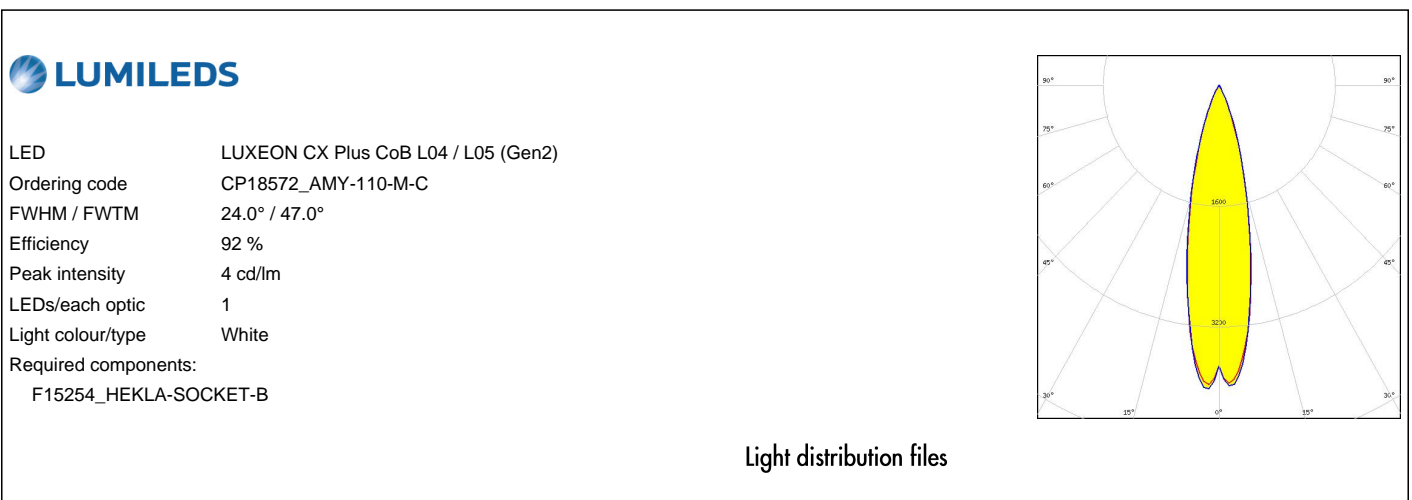
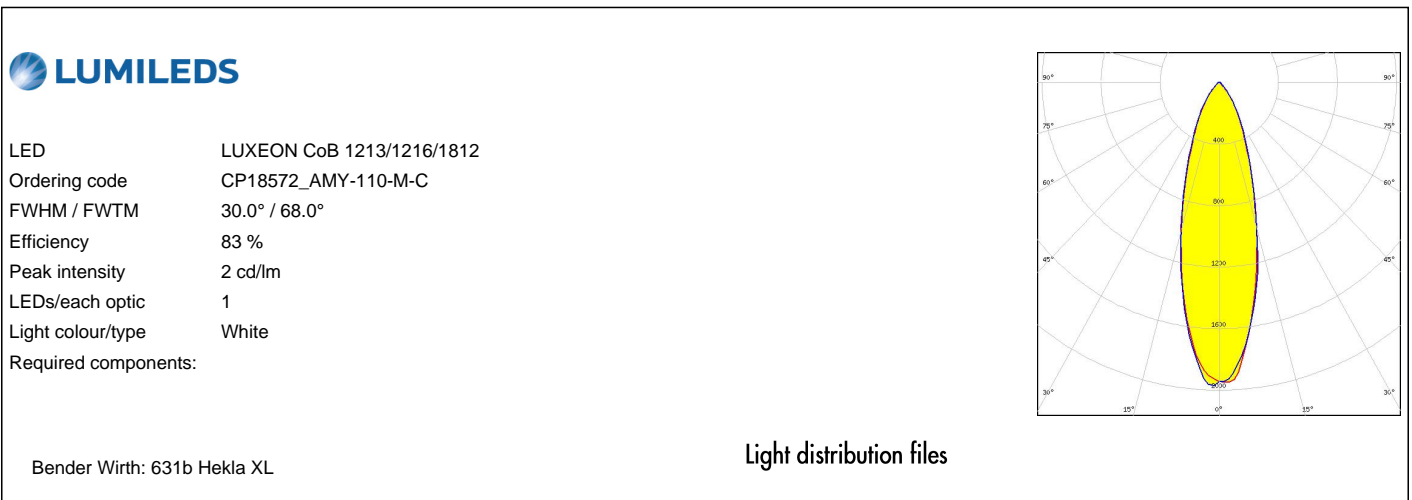
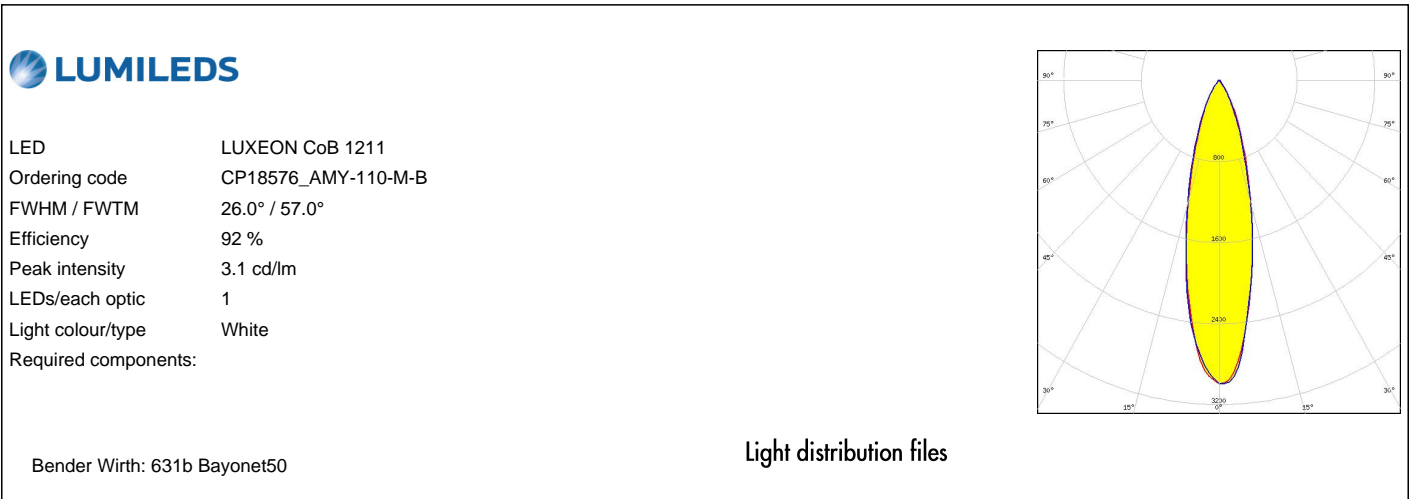

### OPTICAL RESULTS (SIMULATED):



**LED** LUXEON CX Plus CoB M02 / M03 (Gen2)  
**Ordering code** CP18572\_AMY-110-M-C  
**FWHM / FWTM** 24.0° / 44.0°  
**Efficiency** 93 %  
**Peak intensity** 4.6 cd/lm  
**LEDs/each optic** 1  
**Light colour/type** White  
**Required components:**  
 F15256\_HEKLA-SOCKET-D

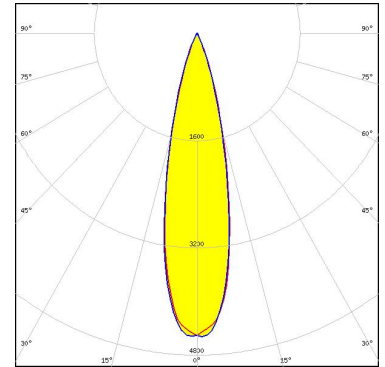

Light distribution files



**LED** CxM-14 (19x19)  
**FWHM / FWTM** 24.0° / 52.0°  
**Efficiency** 95 %  
**Peak intensity** 3.6 cd/lm  
**LEDs/each optic** 1  
**Light colour/type** White  
**Required components:**  
 F17438\_HEKLA-G2-I

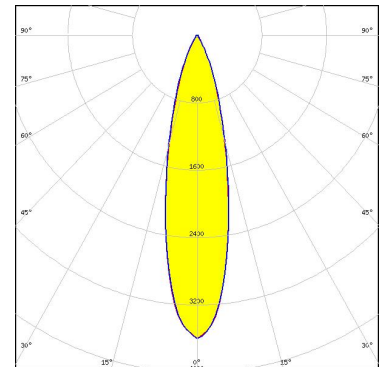

Light distribution files



**LED** CxM-14 (19x19)  
**FWHM / FWTM** 25.0° / 54.0°  
**Efficiency** 93 %  
**Peak intensity** 3.4 cd/lm  
**LEDs/each optic** 1  
**Light colour/type** White  
**Required components:**  
 F17438\_HEKLA-G2-I

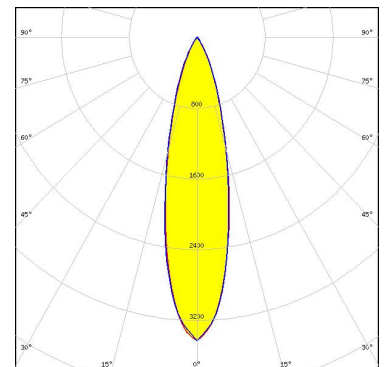

Light distribution files

### OPTICAL RESULTS (SIMULATED):



LED COB J-Type  
Ordering code CP18572\_AMY-110-M-C  
FWHM / FWTM 25.0° / 50.0°  
Efficiency 93 %  
Peak intensity 3.7 cd/lm  
LEDs/each optic 1  
Light colour/type White  
Required components:

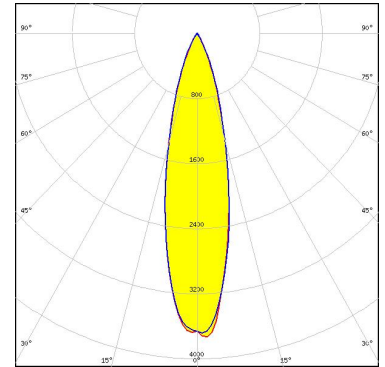

Bender Wirth: 663a Hekla XL

Light distribution files



LED LC016D / LC019D / LC026D / LC033D  
Ordering code CP18576\_AMY-110-M-B  
FWHM / FWTM 24.0° / 51.0°  
Efficiency 92 %  
Peak intensity 3.9 cd/lm  
LEDs/each optic 1  
Light colour/type White  
Required components:

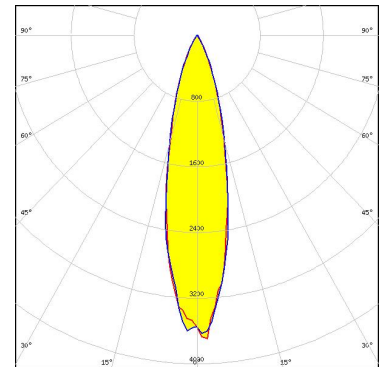

BJB: 47.319.2021

Light distribution files



LED LC016D / LC019D / LC026D / LC033D  
Ordering code CP19029\_AMY-110-M-C-WHT  
FWHM / FWTM 25.0° / 53.0°  
Efficiency 96 %  
Peak intensity 3.7 cd/lm  
LEDs/each optic 1  
Light colour/type White  
Required components:  
F17438\_HEKLA-G2-I

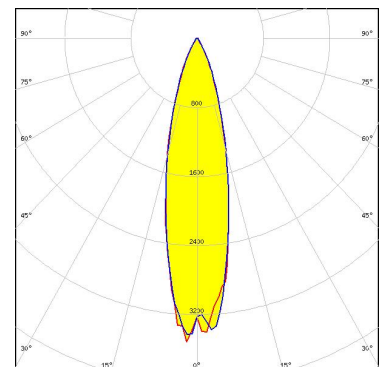

Light distribution files

### OPTICAL RESULTS (SIMULATED):

#### SAMSUNG

LED LC016D / LC019D / LC026D / LC033D  
Ordering code CP18572\_AMY-110-M-C  
FWHM / FWTM 25.0° / 52.0°  
Efficiency 91 %  
Peak intensity 3.7 cd/lm  
LEDs/each optic 1  
Light colour/type White  
Required components:  
F17438\_HEKLA-G2-I

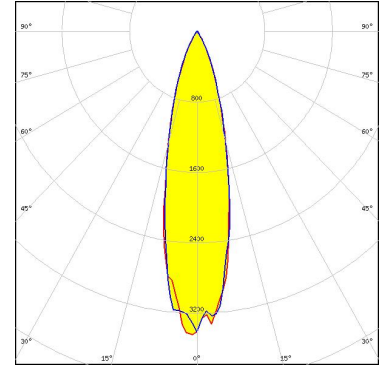

Light distribution files

#### SAMSUNG

LED LC016D / LC019D / LC026D / LC033D  
Ordering code C18568\_AMY-110-M  
FWHM / FWTM 25.0° / 52.0°  
Efficiency 91 %  
Peak intensity 3.7 cd/lm  
LEDs/each optic 1  
Light colour/type White  
Required components:  
F17438\_HEKLA-G2-I

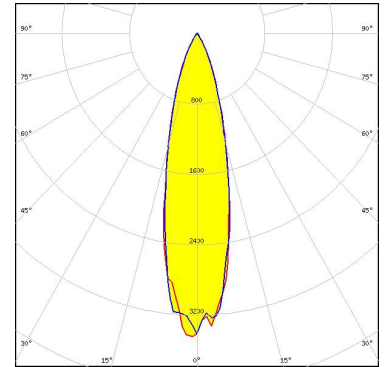

Light distribution files

#### SAMSUNG

LED LC016D / LC019D / LC026D / LC033D  
Ordering code CP19033\_AMY-110-M-B-WHT  
FWHM / FWTM 25.0° / 52.0°  
Efficiency 96 %  
Peak intensity 3.7 cd/lm  
LEDs/each optic 1  
Light colour/type White  
Required components:

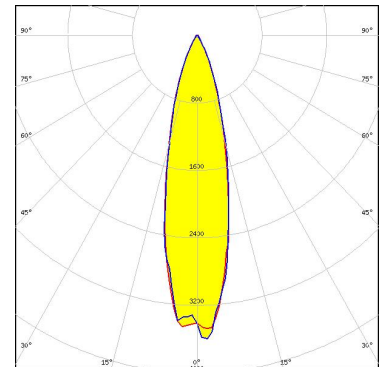

Light distribution files

BJB: 47.319.2021

### OPTICAL RESULTS (SIMULATED):

#### SAMSUNG

LED LC020T (Tunable white)  
Ordering code CP18572\_AMY-110-M-C  
FWHM / FWTM 24.0° / 45.0°  
Efficiency 93 %  
Peak intensity 4.4 cd/lm  
LEDs/each optic 1  
Light colour/type Tunable White  
Required components:  
C16142\_HEKLA-SOCKET-K

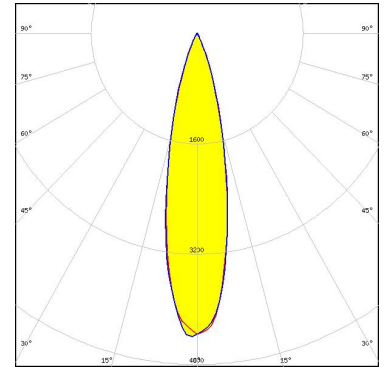

Light distribution files

Bender Wirth: 501 Typ L8

#### SAMSUNG

LED LC040D / LC060D / LC080D  
Ordering code CP18572\_AMY-110-M-C  
FWHM / FWTM 28.0° / 64.0°  
Efficiency 82 %  
Peak intensity 2.2 cd/lm  
LEDs/each optic 1  
Light colour/type White  
Required components:

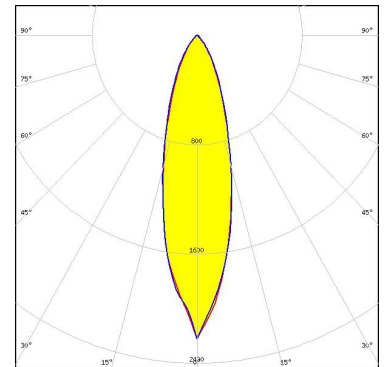

Light distribution files

Bender Wirth: 631b Hekla XL



LED MJT COB LES 14.5  
Ordering code CP18572\_AMY-110-M-C  
FWHM / FWTM 26.0° / 52.0°  
Efficiency 92 %  
Peak intensity 3.6 cd/lm  
LEDs/each optic 1  
Light colour/type White  
Required components:  
F15859\_HEKLA-SOCKET-I

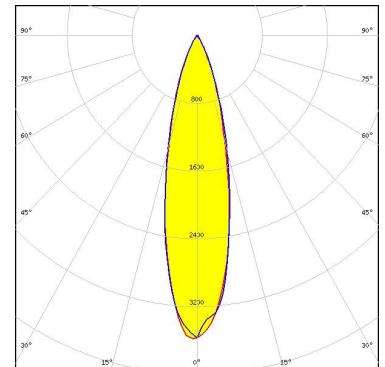

Light distribution files

### OPTICAL RESULTS (SIMULATED):

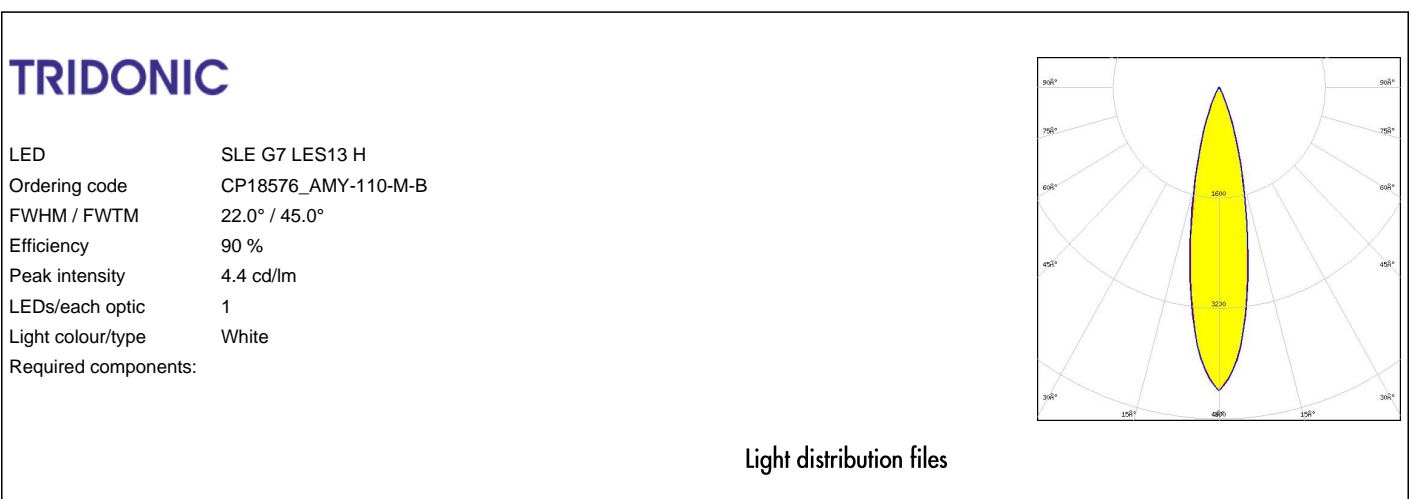
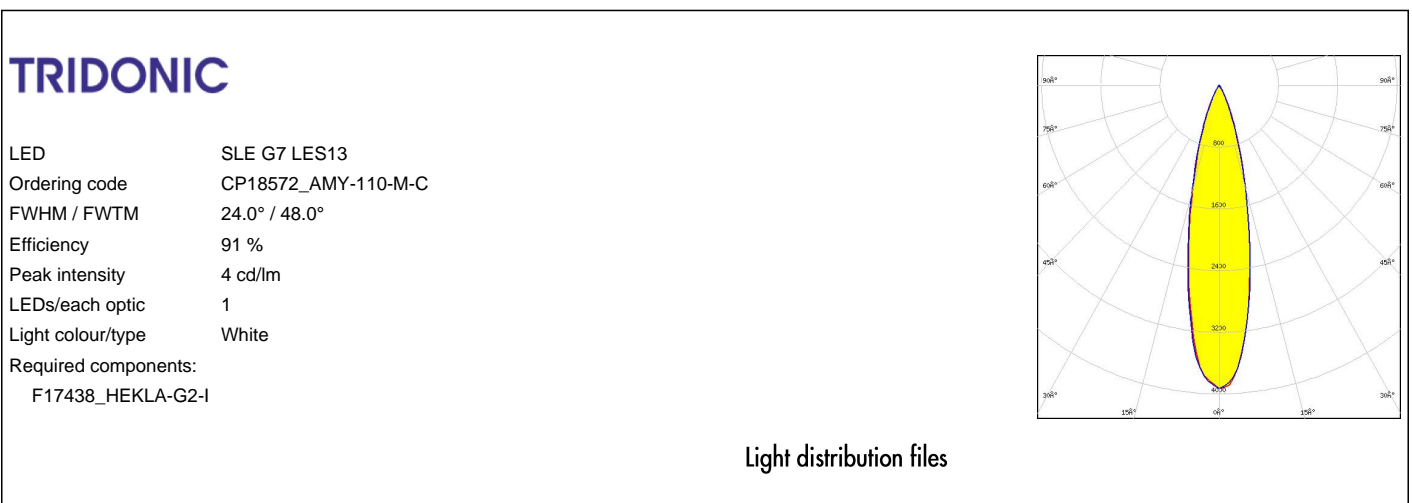
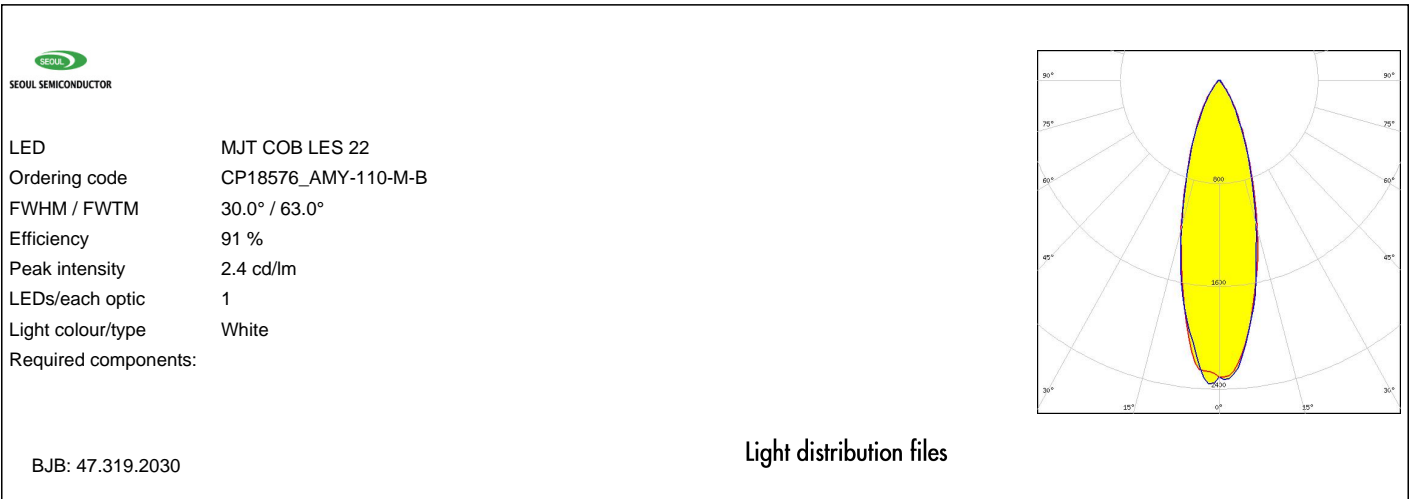



### GENERAL INFORMATION:

NOTE: The typical beam angle will be changed by different color, chip size and chip position tolerance. The typical total beam angle is the full angle measured where the luminous intensity is half of the peak value.

Due to use of high power COB's with this product, special attention to proper thermal design is highly recommended. LEDiL has no liability for direct, indirect or consecutive damages arising from the LEDiL products being used outside of the recommended temperature range.

### MATERIALS:

As part of our continuous research and improvement processes, and to ensure the best possible quality and availability of our products, LEDiL reserves the right to change material grades without notice.

### PRODUCT DATA USER AGREEMENT AND DISCLAIMER:

The measured data in the provided downloadable LEDiL Product Datasheets and Mechanical 2D-Drawings is rounded and provided as reference for planning. LEDiL Oy's optical specifications have been verified by conducting performance testing of the products in accordance with the company's quality system. The reported data are averaged results of multiple measurements with typical variation. LEDiL Oy reserves the right to without prior notification make changes and improvements to its products.

LEDiL Oy assumes neither warranty, nor guarantee nor any other liability of any kind for the contents and correctness of the provided data. The provided data has been generated with highest diligence but the provided data may in reality not represent the complete possible variation range of all intrinsic parameters. Therefore, in certain cases a deviation from the provided data could occur.

LEDiL Oy reserves the right to undertake technical changes of its products without further notification which could lead to changes in the provided data. LEDiL Oy assumes no liability of any kind for the possible deviation from any provided data or any other damage resulting from the usage of the provided data.

The user agrees to this disclaimer and user agreement with the download or usage of the provided files.

#### LEDiL Oy

Joensuunkatu 13  
FI-24240 SALO  
Finland

#### LEDiL Inc.

228 West Page Street  
Suite D  
Sycamore IL 60178  
USA

#### Ledil Optics Technology (Shenzhen) Co., Ltd.

# 405 , Block B  
Casic Motor Building  
Shenzhen 518057  
P.R.CHINA

#### Local sales and technical support

[www.ledil.com/  
where\\_to\\_buy](http://www.ledil.com/where_to_buy)

#### Shipping locations

Poznan, Poland  
Hong Kong, China

#### Distribution Partners

[www.ledil.com/  
where\\_to\\_buy](http://www.ledil.com/where_to_buy)